

Operator's



Spray Star 2004/2004D with Raven 203 System

SN: 200G188

September 2016

Product Support:

Hwy 55 & Poplar Ave; Cameron WI 54822

1-800-891-9435 productsupport@smithco.com

CONTENTS

Introduction	1-13
Introduction	1
Symbols	2-3
General Safe Practices	4
Safe Spraying Practices	5
Safety Instructions	6-7
2000 Gas Specifications	8
2000 Diesel Specifications	9
Set Up	10
Controls & Instruments	12-13
Operation	14-26
Operating Instructions	14-16
Console Features	17
Spray Operation	18-19
Spraying Introduction	20
Turf Management	20
Hose & Handgun Spraying	21
Nozzles	21-22
Calibration Introduction	23
The Nozzle Chart Method of Calibration	24-25
The “128” Method of Boom Sprayer Calibration ...	25-26
Nozzle Charts	27-32
Nozzle Performance Chart #1	27
Nozzle Performance Chart #2	28
Nozzle Performance Chart #3	29
Nozzle Performance Chart #4	30
Nozzle Performance Chart #5	31
Nozzle Performance Chart #6	32
Reference	33-38
Declaration of Conformity	33-37
Quick Reference	38

Thank you for purchasing a **Smithco** product.

Read this manual and all other manuals pertaining to the Spray Star 2000 carefully as they contain safety, operating, assembly and maintenance instructions. Failure to do so could result in personal injury or equipment damage.

Keep manuals in a safe place after operator and maintenance personnel have read them. Right and left sides are from the operator's seat, facing forward.

WARNING

**CALIFORNIA
Proposition 65 Warning**
Engine exhaust and some of its constituents are known to the State of California to cause cancer, birth defects, and other reproductive harm.

WARNING

Failure to follow cautious operating practices can result in serious injury to the operator or other persons. The owner must understand these instructions, and must allow only trained persons who understand these instructions to operate this vehicle.

All **Smithco** machines have a Serial Number and Model Number. Both numbers are needed when ordering parts. Refer to engine manual for placement of engine serial number.











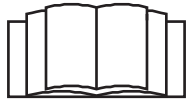



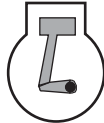
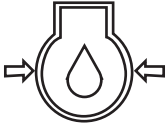

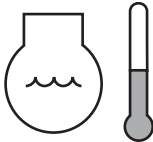
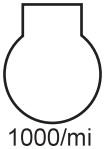

For product and accessory information, help finding a dealer, or to register your product please contact us at www.Smithco.com.



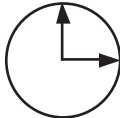
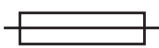





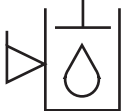

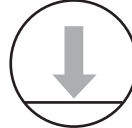
Information needed when ordering replacement parts:

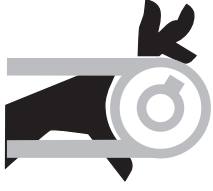
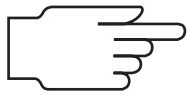
1. Model Number of machine
2. Serial Number of machine
3. Name and Part Number of part
4. Quantity of parts

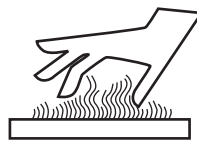
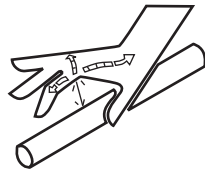
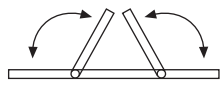
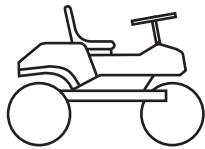
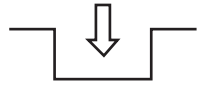
SMITHCO			
<small>WAYNE, PENNSYLVANIA 19087 USA 610-688-4009 Fax 610-688-6069</small>			
SERIAL NO.	kW/hp	DATE OF MFG.	
<input style="width: 100%;" type="text"/>	<input style="width: 100%;" type="text"/>	<input style="width: 100%;" type="text"/>	
MODEL NO.	lb/kg Empty	lb/kg Full	
<input style="width: 100%;" type="text"/>	<input style="width: 100%;" type="text"/>	<input style="width: 100%;" type="text"/>	

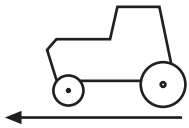
SYMBOLS

	Read Operator's Manual		Electrical Power		No Electrical Power
	Engine - Stop		Engine - Start		Engine - Run
	Engine Oil		Temperature Light		Water Temperature
	RPM		Gasoline		Diesel
	Glow Plug - On		Glow Plug - Off		Glow Plug
	Hour Meter		Hour Meter		Fuse
	Hand Throttle		Choke - Closed		Choke - Open
	Park Brake		Park Brake Release		Hydraulic Oil Level

	Up/Down Arrow		Down/Lower		Up/Raise
	No Smoking		Moving Parts		Manual Operation
	Pinch Point		Step		Hot Surface
	Hydraulic Fluid Penetration		Lift Arm		Tractor
	Engage		Disengage		PTO
	Ground Speed		Fast		Slow
H	High	L	Low	F	Forward
R	Reverse	N	Neutral		Warning Danger Caution

SAFE PRACTICES

1. It is your responsibility to read this manual and all publications associated with this machine.
2. Never allow anyone to operate or service the machine or its optional equipment without proper training and instructions. Never allow minors to operate any equipment.
3. Learn the proper use of the machine, the location and purpose of all the controls and gauges before you operate the equipment. Working with unfamiliar equipment can lead to accidents.
4. Wear all the necessary protective clothing and personal safety devices to protect your head, eyes, ears, hands and feet. Operate the machine only in daylight or in good artificial light.
5. Inspect the area where the equipment will be used. Pick up all debris you can find before operating. Beware of overhead obstructions and underground obstacles. Stay alert for hidden hazards.
6. Never operate equipment that is not in perfect working order or without decals, guards, shields, or other protective devices in place.
7. Never disconnect or bypass any switch.
8. Carbon monoxide in the exhaust fumes can be fatal when inhaled, never operate a machine without proper ventilation.
9. Fuel is highly flammable, handle with care.
10. Keep engine clean. Allow the engine to cool before storing and always remove the ignition key.
11. Disengage all drives and set park brake before starting the engine.
12. Never use your hands to search for oil leaks. Hydraulic fluid under pressure can penetrate the skin and cause serious injury.
13. This machine demands your attention. To prevent loss of control or tipping of the vehicle:
 - A. Use extra caution in backing up the vehicle. Ensure area is clear.
 - B. Do not stop or start suddenly on any slope.
 - C. Reduce speed on slopes and in sharp turns. Use caution when changing directions on slopes.
 - D. Stay alert for holes in the terrain and other hidden hazards.
14. Before leaving operator's position:
 - A. Disengage all drives.
 - B. Set park brake.
 - C. Shut engine off and remove the ignition key.
 - D. If engine has to run to perform any maintenance keep hands, feet, clothing and all other parts of body away from moving parts.
15. Keep hands, feet and clothing away from moving parts. Wait for all movement to stop before you clean, adjust or service the machine.
16. Keep the area of operation clear of all bystanders.
17. Never carry passengers.
18. Stop engine before making repairs/adjustments or checking/adding oil to the crankcase.
19. Use parts and materials supplied by **SMITHCO** only. Do not modify any function or part.
20. Use caution when booms are down as they extend out beyond the center line of the machine.
21. The tank is a confined space, take precaution.

These machines are intended for professional maintenance on golf courses, sports turf, and any other area maintained turf and related trails, paths and lots. No guaranty as to the suitability for any task is expressed or implied.



Persons engaged in the handling, preparation or application of chemicals must follow accepted practices to insure the safety of themselves and others,

1. **WEAR** protective clothing including: gloves, hat, respirator, eye protection and skin covering suitable for protection from chemicals being used.
2. **BATHE** thoroughly after any exposure to chemicals, giving particular attention to eyes, nose, ears and mouth.
3. **CLEAN** equipment and materials in accordance with employer, municipal and state regulations. Use only approved areas and drains.
4. **DISPOSE** of chemicals and rinse solutions by approved and legal means.
5. **PROVIDE** methods and materials for operators to wash eyes and hands immediately during the spraying process.
6. **PROVIDE** methods and materials for control, safe dilution and neutralization of chemical spills during preparation, spraying, transporting and cleanup.
7. Always check and follow the directions and safety warnings of the chemicals to be used.
8. Secure the discharge lines before starting the pump. An unsecured discharge line may whip.
9. Periodically inspect the pump and the system components.
10. Check hoses for weak or worn condition before each use. Make certain that all connections are tight and secure.
11. Do not operate unit with leaks, frayed, kinked hoses or tubing. Repair or replace immediately.
12. Use only pipe, hose and fittings rated for maximum pressure or pressure at which pressure relief valve is set at. When replacing pipe, hose or fittings, use new product.
13. Do not operate any fuel engines in an enclosed area. Be sure the area is well ventilated.
14. Do not use these pumps for pumping water or other liquids for human or animal consumption.
15.  **Do not pump flammable or explosive fluids such as gasoline, fuel oil, kerosene, etc. Do not use in explosive atmospheres. The pump should be used only with liquids compatible with the pump component materials.**
WARNING
16. Be sure all exposed moving parts are guarded and that all coupling devices are securely attached before applying power.
17. Before servicing, disconnect all power, make sure all pressure in the system is relieved, drain all liquids from the system and flush.
18. Protect pump from freezing conditions by draining liquid and pumping rust inhibiting antifreeze solution through the system, coating the pump interior.
19. **TRANSPORT** - Machine **must be stopped** to raise or lower booms. Because of cam system, if booms are raised in transit they can fall forward or backward when coming to a stop or while traveling on uneven terrain.

SAFETY

Read and understand this manual and all safety signs before operating and maintaining. Review the safety instructions and precautions annually.

TAKE NOTE! THIS SAFETY ALERT SYMBOL FOUND THROUGHOUT THIS MANUAL IS USED TO CALL YOUR ATTENTION TO INSTRUCTIONS INVOLVING YOUR PERSONAL SAFETY AND THE SAFETY OF OTHERS. FAILURE TO FOLLOW THESE INSTRUCTIONS CAN RESULT IN INJURY OR DEATH.



SAFETY SIGNAL WORDS

Note the use of the signal words DANGER, WARNING and CAUTION with the safety messages. The appropriate signal word for each has been selected using the following guidelines:



DANGER: Red. Indicates an imminently hazardous situation that, if not avoided, will result in death or serious injury. This signal word is to be limited to the most extreme situations typically for machine components which, for functional purposes, cannot be guarded.



WARNING: Orange. Indicates a potentially hazardous situation that, if not avoided, could result in death or serious injury, and includes hazards that are exposed when guards are removed. It may also be used to alert against unsafe practices.



CAUTION: Yellow. Indicates a potentially hazardous situation that, if not avoided, may result in minor or moderate injury. It may also be used to alert against unsafe practices.



IMPORTANT: Blue. Indicates procedures which should be followed to avoid damage to the machine.

⚠ WARNING

If Safety Decals** have been damaged, removed, become illegible or parts replaced without decals, new decals must be applied. New decals are available from your authorized distributor.

This is a list of decals located on the Spray Star 2000. Part number, description and location will help in reordering a decals.

A	15-463	Decal, Spray Pump	1
B	20-545	Decal, Dash	1
C	20-553	Decal, Center Console	1
D	25-298	Decal, Warning Hot	3
E	25-321	Decal, Refuel Diesel(Diesel only)	1
	25-332	Decal, Proposition 65	1
	30-117	Decal, Ultra Fuel	1
F	25-375	Decal, Hydrualic Oil	1

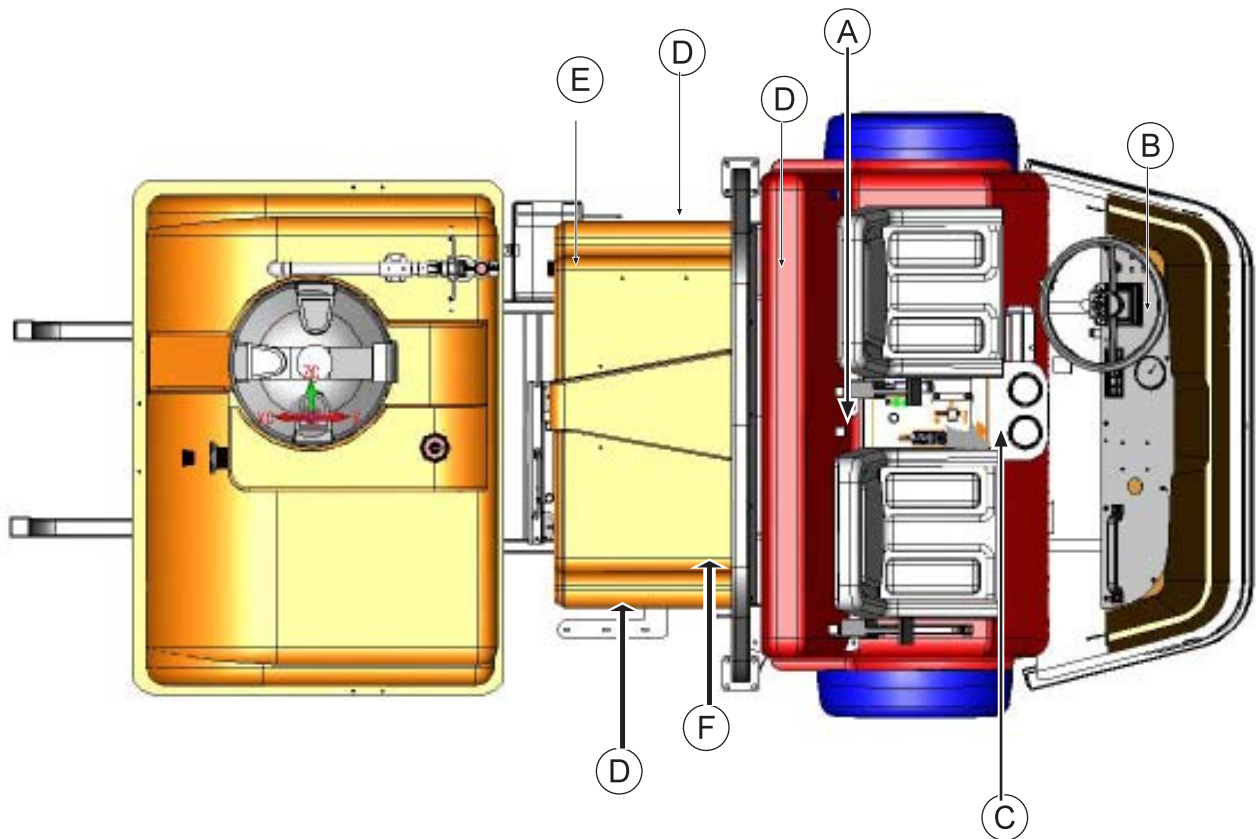

SPECIFICATIONS SPRAY STAR 2000 GAS

WEIGHTS AND DIMENSIONS

Length	132" (335cm) - w/ booms 137" (348 cm) - w/ Cleanload 151" (384 cm)
Width	72" (183cm)
Height w/ Booms Folded	110" (279 cm)
Wheel Base	61" (155cm)
Weight Empty	1990 lbs (903 kg)
Weight Loaded	3605 lbs (1635 kg)

SOUND LEVEL (DB)

At ear level	84 dBA
--------------	--------

ENGINE

Make	Briggs & Stratton
Model#	543477
Type / Spec#	01143E1
Horsepower	31 hp (23 kW)
Fuel	Unleaded 87 Octane Gasoline Minimum
Cooling System	Air Cooled
Lubrication System	Full Pressure
Alternator	20 Amp

WHEELS & TIRE

Front:	Two 20 x 10.00 x 10 NHS Multi-Rib; 20 psi (1.4 bar)
Rear:	Two 24 x 13.00 x 12 NHS Multi-Trac; 20 psi (1.4 bar)

SPEED

Infinitely Variable	0-10 m.p.h. (0-16 kph)
---------------------	------------------------

BATTERY

	Automotive type 24F - 12 volt
BCI Group	Size 24
Cold Cranking Amps	900 minimum
Ground Terminal Polarity	Negative (-)
Maximum Length	10.25" (26 cm)
Maximum Width	6.88" (17 cm)
Maximum Height	10" (25 cm)

FLUID CAPACITY

Crankcase Oil	See Engine Manual
Fuel	10 gallon (37,85 liters)
Hydraulic Fluid	5 gallon (19 liters)
Grade of Hydraulic Fluid	SAE 10W-40 API Service SJ or higher Motor Oil

OPTIONAL EQUIPMENT

15-618	Water Meter Kit (liters)	14-515	Water Meter Kit (Gallons)
20-503	Chemical Cleanload Safe Fill	15-850	Sunshade Canopy
30-009	Manual Rewind Hose Reel, 200-foot/61-meter capacity		
30-010	Electric Rewind Hose Reel, 200-foot/61-meter capacity		
30-004	Foam Marker	30-006	Clear water Wash Tank
15-835	Tank Rinsing System	30-141	26 Gal Wash System
17-585	18' HD Super Boom	17-580	20' HD Super Boom
17-590	Lazer-Beam Automatic Boom for HD Booms	31-004	All Weather Top



SPECIFICATIONS *SPRAY STAR 2000 DIESEL*

WEIGHTS AND DIMENSIONS

Length	132" (335cm) - w/ booms 137" (348 cm) - w/ Cleanload 151" (384 cm)
Width	72" (183cm)
Height w/ Booms Folded	110" (279 cm)
Wheel Base	61" (155cm)
Weight Empty	1990 lbs (903 kg)
Weight Loaded	3605 lbs (1635 kg)

SOUND LEVEL (DB)

At ear level	98 dBA
--------------	--------

ENGINE

Make	Kubota
Model#	D1105-E3B
Horsepower	25 hp (18.5 kW)
Fuel	No.1-D or No. 2-D, S500: Low Sulfur Diesel (LSD) less than 500 ppm or 0.05 wt. % No1-D or No.2-D, S15: Ultra Low Sulfur Diesel (ULSD) less than 15 ppm or 0.0015 wt. %
Cooling System	Liquid Cooled
Lubrication System	Full Pressure
Alternator	15 Amp

WHEELS & TIRE

Front:	Two 20 x 10.00 x 10 NHS Multi-Rib; 20 psi (1.4 bar)
Rear:	Two 24 x 13.00 x 12 NHS Multi-Trac; 18 psi (1.3 bar)

SPEED

Infinitely Variable	0-10 m.p.h. (0-16 kph)
---------------------	------------------------

BATTERY

	Automotive type 24F - 12 volt
BCI Group	Size 24
Cold Cranking Amps	900 minimum
Ground Terminal Polarity	Negative (-)
Maximum Length	10.25" (26 cm)
Maximum Width	6.88" (17 cm)
Maximum Height	10" (25 cm)

FLUID CAPACITY

Crankcase Oil	See Engine Manual
Fuel	7 gallon (26.5 liters)
Hydraulic Fluid	5 gallon (19 liters)
Grade of Hydraulic Fluid	SAE 10W-40 API Service SJ or higher Motor Oil

OPTIONAL EQUIPMENT

15-618	Water Meter Kit (liters)	14-515	Water Meter Kit (Gallons)
20-503	Chemical Cleanload Safe Fill	15-850	Sunshade Canopy
30-009	Manual Rewind Hose Reel, 200-foot/61-meter capacity		
30-010	Electric Rewind Hose Reel, 200-foot/61-meter capacity		
30-004	Foam Marker	30-006	Clear water Wash Tank
15-835	Tank Rinsing System	30-141	26 Gal Wash System
17-585	18' HD Super Boom	17-580	20' HD Super Boom
17-590	Lazer-Beam Automatic Boom for HD Booms	31-004	All Weather Top

SETUP

The Spray Star 2000 arrives from **SMITHCO** setup and ready for service. Depending on freight conditions the battery may have to be installed.

The spray system is normally shipped attached to the 2000 Prime Mover. If a spray system is to be fitted to a Prime Mover by a dealer or factory, assemble and attach the components in accordance with the parts drawings in the *Spray Star 2000 Parts/Service Manual*.

1. Check the tire pressure. The front and rear tires are 20 psi (1.4 bar).
2. Battery is located under the seat. This is a negative grounding system.

⚠ WARNING

Connecting battery cables to the wrong post could result in personal injury and/or damage to the electrical system. Make sure battery and cables do not interfere or rub on any moving part. Connect red positive (+) cable (A) to battery first. When disconnecting remove black negative (-) cable (B) first.

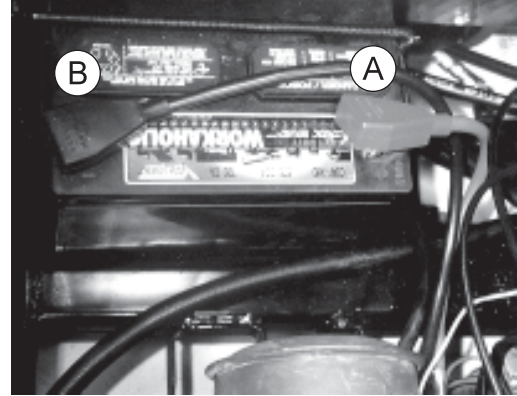

3. Check hydraulic fluid level in tank located under the seat. Remove cap and add SAE 10W-40 API Service SJ or higher motor oil if necessary. Fluid level should be about 2-2 $\frac{1}{2}$ " (5-6.4 cm) from the top of the tank when cold. **DO NOT OVERFILL.**
4. Fill fuel tank, located on the left side, with **GAS**: Unleaded 87 Octane gasoline (minimum) **DIESEL**: No.1-D or No. 2-D, S500: Low Sulfur Diesel (LSD) less than 500 ppm or 0.05 wt.%. No1-D or No.2-D, S15: Ultra Low Sulfur Diesel (ULSD) less than 15 ppm or 0.0015 wt.%

⚠ DANGER

Fuel is flammable, caution must be used when storing or handling it. Do not fill fuel tank while engine is running or in an enclosed area, fumes are explosive and dangerous to inhale. DO NOT SMOKE while filling the fuel tank. DO NOT OVERFILL.

5. Machine should be greased before starting, refer to *Spray Star 2000 Parts/Service Manual* for location.
6. Attach the Spray Boom and any other Optional Equipment to the Prime Mover, in accordance with instructions in the *Spray Star 2000 Parts/Service Manual*. The nozzles must be the correct distance above the turf as described in *Turf Spraying Guide*. The spray boom must operate properly and the outer sections must break away safely if an object is struck by them, they must then return to normal operation position.
7. Be sure to double check boom heights, nozzle spacing and displacement before spraying.
8. Machine is shipped with windshield washer fluid in Spray System to prevent freezing. Flush system completely with clear water. Fill tank with water and retighten the four bolts used to hold the tank in place.

⚠ WARNING

Never allow pump to run dry! The valve on the suction side of the pump (between the pump and tank) must be fully open whenever the pump is operated.

9. Read operating instructions before starting.

CONTROLS & INSTRUMENTS 2000

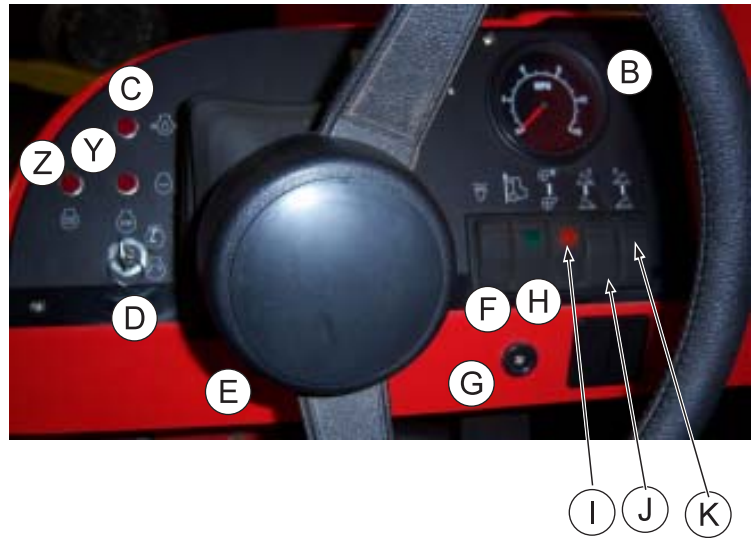

- A. Hour Meter - The hour meter indicates hours of machine operation. It operates only when the ignition switch is on.
- B. Speedometer - The Speedometer indicates ground speed of the vehicle in miles per hour.
- C. Oil Light - The oil light should come on when the ignition is on without the engine running and go out when the engine is running. The oil light will light when the oil pressure is low. If oil light should come on, shut engine off immediately and find the cause.
- D. Ignition Switch - The ignition switch has three positions: Off - Run - Start.
- E. Tilt Steering - Hold lever down and adjust steering wheel to desired position and release lever.
- F. Lights - This rocker switch turns lights on by pushing on the top and off by pushing on the bottom.
- G. Buzzer - The buzzer sounds if the pump is running dry.
- H. Ground Speed (Cruise) Control - This rocker switch initiates cruise control by pushing on the top and turning it off by pushing on the bottom. Works with ground Speed Control Foot switch.
- I. Spray Pump - This toggle switch turns the spray pump on by pushing on the top and off by pushing on the bottom.
- J. Left Boom Switch - This rocker switch lifts and lowers the left boom.
- K. Right Boom Switch - This rocker switch lifts and lowers the right boom.
- L. Hand Throttle - The hand throttle is used to regulate engine speed.
- M. Choke - The choke is used in starting the engine. Pull choke out to close choke plate when starting a cold engine. Push in when engine starts. A warm engine may not require "choking" to start.
- N. Park Brake - The park brake is only a parking brake. Pull back to release, push forward to apply. Some adjustment can be made by turning the knob clockwise to tighten and counter clockwise to loosen.



- O. Spray Boss Control - Engages and disengages speed boss. Forward is engage and all the way back is disengage. When the lever is engaged it sets a stop for the accelerator. The accelerator pedal must be used to maintain this speed. To adjust speed use the knob on the end of the lever, counter clockwise increases speed and clockwise decreases speed. Disengage the lever and you will have full accelerator pedal range.
- P. Cup Holder - Holds two x-large cups.

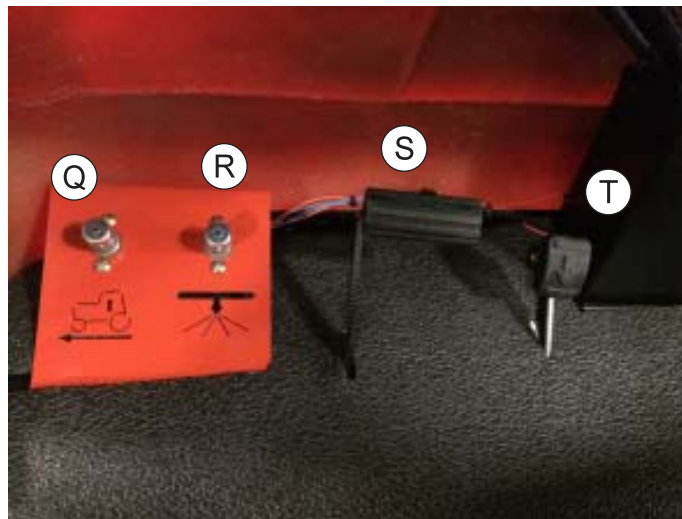

- Q. Ground Speed (Cruise) Control Foot Switch - When rocker switch is turned on and desired speed is obtained, push foot speed control switch to set cruise.
- R. Master Boom Switch - located on the left floorboard is used to override the master switch on the computer console of the spray systems. By pushing down it will turn on/off the booms. ***For the 440 System only*** the Master Switch on the computer **must be off** for the master boom control switch to work.
- S. Accelerator Pedal - This pedal controls ground speed. Press pedal to increase speed. Varying the amount of movement of the pedal will vary the ground speed.
- T. Reverse Pedal - This pedal controls reverse. Press pedal to move machine in reverse.
- Y. Water Temperature Light (**Diesel Only**)- Temperature light will come on and a buzzer will sound when the engine starts to overheat.
- Z. Glow Plug (**Diesel Only**)- When ignition is turned on, glow plug lights when ready to start.

GROUND SPEED CONTROL

The ground speed control does not work the same as an automotive type cruise. The ground speed control is located on the center floorboard and is used to lock forward speed.

TO ENGAGE:

1. Flip rocker switch 'On' (green light).
2. Obtain desired speed with foot pedal.
3. Step on foot switch to lock speed.
4. Push foot switch again to disengage.

CAUTION

To avoid abrupt stop, place foot on traction pedal before disengaging speed control.

OPERATION

Before operating the Spray Star 2000, become familiar with all controls and functions. Also complete all maintenance requirements and read all safety warnings. Knowing the Spray Star 2000 thoroughly, how it operates, and by doing the prescribed maintenance steps, you can expect trouble free operation for years to come.

SAFETY

Safety needs to always be the concern of an operator of a moving vehicle or any machine with moving parts.

1. Keep all shields and guards in place.
2. Keep the parking brake engaged any time the operator is away from the vehicle or whenever service is performed.
3. Always wear the necessary protective clothing and equipment.
4. Turn engine off when refueling or performing maintenance not specifically requiring engine power.

DAILY CHECKLIST

1. Check the engine oil level. Add as needed. **DO NOT OVERFILL**. Refer to engine owner's manual for oil grade and procedure.
2. Tire pressure should be 20 psi (1.4 bar) maximum.
3. Inspect the electrical system and battery cables for loose connections or frayed wiring. Replace any faulty equipment or tighten if loose.
4. Check hardware for loose or missing nuts, bolts, screws, etc., and tighten or replace as needed.
5. Inspect hydraulic lines for damage or leaks. Never use hands to inspect for leaks.
6. Check the hydraulic fluid level. The hydraulic fluid tank is located on the left side of the machine. The fluid level should be 2"-2½" (5 - 6.4 cm) from the top of the tank when cold. Use only SAE 10W-40 API Service SJ or higher Motor Oil.
7. Inspect the steering, throttle and shift linkages for good hookups and clear travel.
8. Check controls for smooth, proper working operation. Lubricate as needed.
9. Check park brake adjustments. Adjust as required.
10. Check anti-vibration mounts on engine frame.

STARTING THE ENGINE

1. Gas - The ignition switch is located on the dashboard. Insert the key (A) and turn clockwise until the engine starts (C). Release the key and it will return to the run position (B). Use the choke and hand throttle as necessary.
2. Diesel - Insert the key (A) and turn clockwise to (B). When glow plug light goes off Turn key to (C) until the engine starts. Release the key and it will return to the run position (B).
3. Allow engine to idle and warm up before selecting direction of travel.

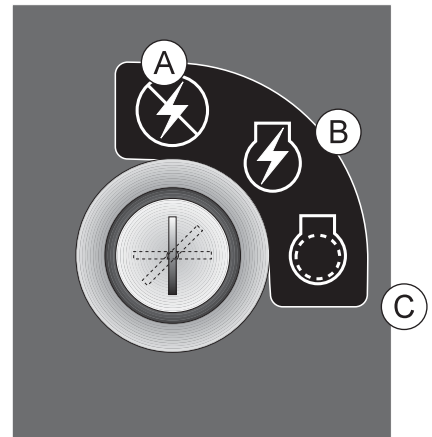

STOPPING THE ENGINE

IMPORTANT

If the engine has been running under high power, let it run at slow idle speed a few minutes to cool the engine down, before turning the ignition switch to the OFF position.

1. Disengage spray pump.
2. Move the throttle lever to "slow" and turn ignition key to the "off" position.
3. Remove the ignition key and engage the park brake.

CAUTION

Never leave the vehicle unattended with the engine running. Always bring the vehicle to a complete stop, engage park brake, turn key off and remove key.

PARTS MANUALS AVAILABLE ONLINE AT smithco.com

Before using the Spray Star, the operator and spray technician must familiarize themselves with all of the information on chemical spraying contained in the *Turf Spray Guide*.

⚠ IMPORTANT

All testing and calibrating of sprayers is to be done with water, not chemicals. This insures the safety to all involved in performing the calibration operation. Only after all calibration procedures are completed should chemical be added to the sprayer.

TOWING UNIT

When it is necessary to move the Spray Star 1750 without the engine running, the bypass valve located on the back of the hydrostatic pump must be "open" by turning it $\frac{1}{4}$ turn to open. The valve is located on the bottom of the pump. An "open" valve allows fluid to pass through the wheels freely. When normal driven operation is desired, valve should be "closed" by turning it clockwise. Failure to "close" the valve with engine running means no power to wheels.

HILLSIDE OPERATION

Do NOT stop or start suddenly on any slope. Be especially cautious when changing direction. Do NOT operate on slopes greater than 10°.

BATTERY

Batteries normally produce explosive gases which can cause personal injury. Do not allow flames, sparks or any ignited object to come near the battery. When charging or working near battery, always shield your eyes and always provide proper ventilation.

Battery cable should be disconnected before using "Fast Charge".

Charge battery at 15 amps for 10 minutes or 7 amps for 30 minutes. Do not exceed the recommended charging rate. If electrolyte starts boiling over, decrease charging.

Always remove grounded (-) battery clamp first and replace it last. Avoid hazards by:

1. Filling batteries in well-ventilated areas.
2. Wear eye protection and rubber gloves.
3. Avoid breathing fumes when electrolyte is added.
4. Avoid spilling or dripping electrolyte.

⚠ WARNING

Battery Electrolyte is an acidic solution and should be handled with care. If electrolyte is splashed on any part of your body, flush all contact areas immediately with liberal amounts of water. Get medical attention immediately.

JUMP STARTING

⚠ WARNING

Use of booster battery and jumper cables. Particular care should be used when connecting a booster battery. Use proper polarity in order to prevent sparks.

To jump start (negative grounded battery):

1. Shield eyes.
2. Connect ends of one cable to positive (+) terminals of each battery, first (A) then (B).
3. Connect one end of other cable to negative (-) terminal of "good" battery (C).
4. Connect other end of cable (D) to engine block on unit being started (NOT to negative (-) terminal of battery)

To prevent damage to other electrical components on unit being started, make certain that engine is at idle speed before disconnecting jumper cables.

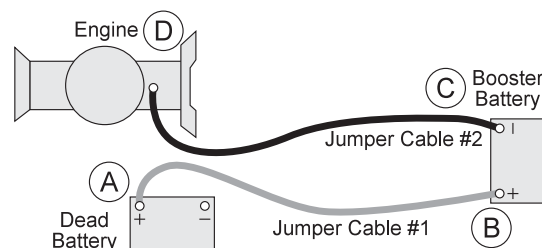

OPERATION (CONTINUED)

SPRAYER VALVE SETTINGS AND SPRAY TANK AGITATION

The gate valve on the suction side of the pump, between the tank and the pump must be open before pump is engaged. Close this valve only when necessary to clean the filter with spray material in the spray tank.

There is one manual flow control valve on the discharge side of the spray system. This valve controls the agitator. This valve may be opened as much as necessary to provide hydraulic agitation through the quadrajet agitator in the tank bottom. This valve may be partially closed to prevent or reduce foam buildup from the spray materials inside the tank. When the liquid level in the spray tank reaches a certain level (usually 1-25 gallons (3.8-95 Liters) depending on terrain and other conditions) it may be necessary to close the valve in the agitator line in order to prevent loss of suction prime.

If your Spray Star is fitted with a hose reel, there is a second ball valve on the discharge system to supply material to the hose reel.

The Quadrajet agitation system operates with four venturi jets in the tank bottom. These jets have replaceable orifice discs which discharge the following amounts of spray material.

Nozzle Diameter	Input to Agitator in gpm	Input to Agitator in L/min	Agitator Pressure in psi	Agitator Pressure in bar	Agitator Output in gpm	Agitator Output in L/min
1/8"	1.9	7.2	25	1.7	6.3	23.8
1/8"	2.7	10.2	50	3.4	10.0	37.9
1/8"	3.8	14.4	100	6.9	15.0	56.8
5/32"	2.8	10.6	25	1.7	7.6	28.8
5/32"	4.2	15.9	50	3.4	12.2	46.2
5/32"	5.5	20.8	100	6.9	17.5	66.2
3/16"	3.6	13.6	25	1.7	9.1	34.4
3/16"	5.6	21.2	50	3.4	14.3	54.1
3/16"	7.9	29.9	100	6.9	18.7	70.8

You can change orifice disc sizes to enhance spray system performance. Smaller discs reduce amount of agitation (desirable in some foaming materials) and make more dischargeable liquid available for nozzles. Larger (or none) discs increase amount of agitation and make less dischargeable liquid available for nozzles.

INITIAL SYSTEM SETUP

1. Fill tank with water only.
2. Place Master On/Off switch to On, Boom On/Off switches to Off, and open tank shut-off valves.
3. With Pump **not running**, fully open main line hand valve and totally close agitator line hand valve.
4. Verify that each boom solenoid valve operates by operating Boom On/Off switches and that no nozzles are plugged.
5. Place all Boom On/Off switches On.
6. Hold the Pressure Adjust switch in the increase position until the pressure stops increasing and begins to decrease.
7. Adjust agitator line hand valve for desired agitation.
8. Close the main line hand valve, if necessary, to set the maximum desired operating pressure. (The maximum pressure should be approximately 10 psi (69 kPA), above the normal spraying pressure.)
9. Hold the Pressure Adjust switch in the decrease position until the pressure stops decreasing and begins to increase. If desired minimum pressure cannot be obtained, install larger bypass hose.
10. Verify the desired maximum pressure of the sprayer system by repeating step 6.



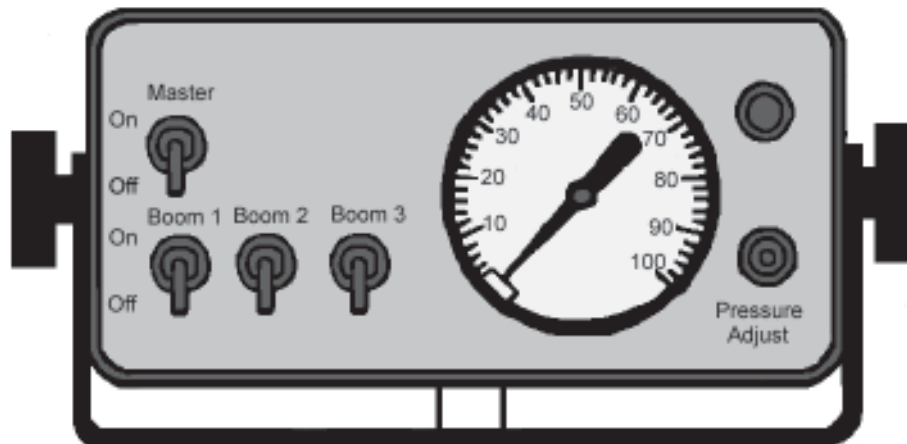

- A. Master Boom Switch - Activates or stops boom spraying.
- B. Individual Boom Switches - Used to activate any of up to 3 booms on a sprayer.
- C. PSI Gauge - Indicates the pressure of fluid in the system.
- D. Pressure Switch - Used to activate the motorized control valve
- E. Fuse Holder - The fuse holder holds one 15 Amp fuse.

CALIBRATING THE PRESSURE GAUGE

The pressure tap on the Raven Sprayer Control system is located away from the nozzles, thus, there can be a pressure difference between nozzle pressure and gauge pressure at the console. Therefore, for best results, Raven recommends the following procedure:

1. When the sprayer is ready and the tank is filled with water (No chemicals at this time), attach an **accurate** pressure gauge to a nozzle in place of the spray tip.
2. Start up the pump, turn on the electric shut-off valves and adjust the pressure control valve so that the desired pressure is maintained on the gauge at the nozzle.
3. Because of pressure drops through the system, the pressure shown on the gauge in the console may read slightly higher than the gauge at the nozzle. Use this console pressure reading as your reference point for maintaining the desired pressure at the nozzle.

PROCEDURE TO RE-CALIBRATE FLOWMETER

1. Enter a Meter Cal number of 10 in Meter Cal Button
2. Enter a Total Volume of Calibrating the Pressure Gauge in Total Volume button
3. Switch Off all booms.
4. Remove a boom hose and place in calibrated 5 gallon container
5. Switch on appropriate boom switch and master switch. Pump exactly 10 gallons.
6. Readout in Total Volume is the new Meter Cal Number. Should be within 3% of number stamped on flowmeter.
7. Repeat the procedure several times to ensure accuracy.
8. To verify calibration, fill applicator tank with predetermined amount of measured liquid. **DO NOT RELAY ON GRADUATION NUMBERS ON TANK.** Empty tank under normal operatin conditions. If the number under totla volume is different from the predetermined amount of measure by more than 3% compete calculation in back of book.
9. Enter corrected Meter Cal before resumim application.

SPRAY OPERATION

SPRAY OPERATION (After Proper Setup and Calibration)

1. Add 1/2 the amount of water required for the spray operation to tank using air gap filler.
2. Start engine, set engine speed below 2000 RPM, and engage pump after taking all previously described safety and operation precautions.
3. Open agitator valve.
4. Add chemicals (taking all precautions described in this manual and by the chemical manufacturer).
 - a. Liquids may be poured directly into tank.
 - b. Wettable powder chemicals must be pre-mixed with water in a container to form a slurry. The mixture is then added to the tank through the fillwell strainer.
 - c. Chemical in soluble packs are place into the fillwell strainer basket and dissolved by adding water through the basket.

The balance of the water required for the spray operation is added to the tank through the fillwell strainer, using the air gap filler. This will wash any undissolved chemical into the tank.

5. Transport to sprayer site with and agitator operating.
6. Set Engine speed between 2000-3200 RPM.
7. (Optional) Engage ground speed control.
8. Obtain desired spraying speed before activating spray with switches on spray control console.
9. The master boom switch, located on the left floorboard is used to override the master switch on the computer console of the spray systems. By pushing down it will turn on/off the booms. *For 834 Systems* the Master Switch on the computer **must be on** for the master boom control switch to work. *For the 440 System* the Master Switch on the computer **must be off** for the master boom control switch to work.

CAUTION

Review the capacity of nozzles being used. Total capacity of all nozzles plus agitation system must not exceed pumping system capabilities refer to *Spraying Procedure* section of this manual. FLUSH PUMP AFTER USE

Shut-Off	20GPM	40GPM	60GPM	80GPM	100GPM
120psi	100psi	80psi	60psi	30psi	10psi
100psi	95psi	76psi	52psi	26psi	5psi
80psi	75psi	62psi	45psi	21psi	-
60psi	55psi	40psi	25psi	5psi	-

To determine the correct performance data for your application, first shut off all flow on discharge side of pump and determine the shut-off pressure at the pump. Use this Shut-Off pressure to determine which line of data applies.

One of the most common causes for faulty-pump performance is corrosion inside the pump. Flush the pump and entire system with a solution that will chemically neutralize the liquid pumped. Mix according to manufacturer's directions. This will dissolve most residue remaining in the pump, leaving the inside of the pump clean for the next use.

TO PREVENT CORROSION

After cleaning the pump as directed, flush it with a permanent type automobile antifreeze (Prestone, Zerex, etc.) containing a rust inhibitor. Use a 50% solution that is, half antifreeze and half water. Then coat the interior of the pump with a substance which will prevent corrosion such as Fluid Film or WD40. If unit will not be used for an extended period of time, disconnect hoses into and out of the pump, seal openings to the pump with caps or tape. Dispose of fluids according to all federal, state and local regulations.

IMPORTANT

All chemicals and chemical residue must be removed after each use. Dispose of fluids and residue according to all federal, state and local regulations.

SPRAYER CLEANING

Empty tank and clean unit thoroughly after each use following these instructions:

1. Remove coupling and rinse inside of tank thoroughly with clean water, replace coupling.
2. Fill tank ten percent full with clean water, start pump and discharge water through spray hose or spray boom (with nozzles removed), until empty.
3. Remove drain coupling again and rinse tank interior thoroughly.
4. Rinse exterior of sprayer thoroughly with clean water.
5. Remove bowl from sprayer filter (on operators left hand side of the spray tank). Remove stainless steel screen. Wash bowl and screen thoroughly. Apply thin layer of petroleum jelly to O-ring or gasket. Replace screen and bowl, taking care to position O-ring or gasket properly. Hand tighten.

MANUAL HOSE REEL

Located at the back of the Spray Star behind the tank. Open the ball valve located near the pump to allow fluid to flow into the hose reel. Place the lockout pin in the unlocked position by pulling and turning it half a turn, this will allow you to pull out additional hose or to use the handle and wind up the hose. To prevent movement during transport or storage place the lockout pin in the locked position.

ELECTRIC HOSE REEL

Located at the back of the Spray Star behind the tank. Open the ball valve located near the pump to allow fluid to flow into the hose reel. To unwind hose just pull on the hose to get the desired amount. To wind up the hose make sure the toggle switch is in the ON position, push the momentary push button switch until you have reeled in the amount of hose desire. Turn off the safety switch when not in use.

FOAM MARKER

Located to the right of the control panel. Use lever on compressor to designate which boom is to be used to dispense foam. Use dial located on the foamer to adjust pressure for the amount of foam that will be dispensed. Switch on the compressor also turns foamer on or off.

SPRAYING INTRODUCTION

This section is intended to offer practical guidelines for the distribution of liquid chemicals over an area of turfgrass such as golf courses, park land, school grounds and lawns. SMITHCO makes no representation as to the suitability of any technique or product for any particular situation. This section is suitable for self-propelled spray vehicles or sprayers mounted onto vehicles.

Boom Spraying is the most effective, accurate and efficient method of applying chemicals to large turf areas. It may be done by means of:

- A dedicated spray vehicle
- A sprayer mounted upon a utility vehicle

Sprayers are typically equipped with wide spray booms. Generally these booms are between 15 feet (4.5 m) and 20 feet (6 m) in width. They are divided into three sections, with hinges that permit the long outer sections to automatically move out of the way and reset if an obstacle such as a tree or fence is in your path.

To minimize the chance for missed areas or double application use a device to mark the outside boundaries of each spray swath. Foam markers and dye markers are advisable.

TURF MANAGEMENT

Turf management chemicals are made for four general purposes:

1. **Fungicides:** Prevent or cure fungus on turfgrass. They are made in 2 general types:
 - Systemic - Chemicals enter the plant system and protect or cure it of, fungus.
 - Contact - Kills fungus with which it comes into contact.
2. **Insecticides:** Eliminate damaging insects and worms (such as grubs, beetles, ants, etc.)
3. **Herbicides:** Control and eliminate undesirable weeds and grass from turf areas and non-turf areas such as bunkers, trails, fences, etc.
4. **Nutrients & Fertilizer:** Promote growth, beauty and color in turfgrass.

Some materials have to be applied so that they get into the soil below the plant leaves, This is called "*soil application*". In order to do this, they are best applied with a *large volume of water*. They are often then *watered-in* using the irrigation system. This type of chemical material includes systemic chemicals and chemicals designed to destroy pests which live in the thatch and the soil.

Other materials must be applied to reach a problem that is present on the plant leaves. This is called "*Foliar Application*" and requires a *lower volume* of water. Instead of irrigation water, these materials are further activated by dry air and sunshine. They include contact fungicide and many herbicides.

The user of sprayers and chemicals must follow the directions provided with the spray material. It is the only way to insure safe and effective results. It provides information on how much chemical and how much water is to be applied to the area to be sprayed.

Though there are many types and sizes of nozzles, two specific types have proven most successful in turfgrass management.

- The first type is **target-directed**. It sprays material in a direct line downwards to the target turfgrass. These are flat fan nozzles, commonly referred to as TeeJet nozzles. They are available in a wide variety of sizes for any required discharge volume rate. They are the best for many contact or foliar applied pesticides. They are spaced either 10" (25 cm) or 20" (51 cm) apart and overlap one another by about $\frac{1}{3}$.
- The second type useful in turf management are **broadcast** type nozzles. They are commonly referred to as raindrop or floodjet nozzles. They spray a hollow-cone shaped pattern of much larger droplets which fall quickly to the turf under their own weight. They are best for systemic pesticides or any material requiring a large volume of water for soil application. The larger droplets are not as subject to drift from wind and are a safer, more environmentally friendly choice in many situations.

A handgun (hand-nozzle or hand-lance) is used to control and direct the spray pattern to the ground, shrub or tree. They must be constructed of long lasting and noncorrosive materials such as brass, stainless or aluminum. The handgun fits to a hose of any length from the sprayer allowing operator mobility. The hose should be as short as possible while still permitting operator mobility.

Liquid loses pressure due to friction as it travels through the hose, 1-3 psi (0.07-0.21 bar) for each foot (30 cm) of hose. For most operations $\frac{1}{2}$ " (1.25 cm) inside diameter hose is adequate. Trees over 40 ft (12 m) high require $\frac{3}{4}$ " (2 cm) inside diameter hose and a sprayer pump capable of delivering a volume of at least 20 gpm (75 lpm) and a pressure of at least 400 psi (28 bar).

NOZZLES

Always be alert to the possibility of a plugged or damaged nozzles. Serious misapplications may result. Check nozzle output periodically.

Modern nozzles use spring and diaphragm check valves to insure positive cutoff of chemicals without drip.

Snap-on caps make replacing and cleaning nozzles, quick, easy and fool proof with proper reinstallation.

An operator can see at a glance if all nozzles are the same size by the color code.

3 FUNCTIONS FOR A SPRAY BOOM NOZZLE

1. Regulating the flow is done through size of the orifice (opening) within the nozzle. All nozzles, regardless of type, have some point within them that regulates the flow of liquid. Obviously, the larger the opening the greater the rate of flow volume. Volume is expressed in Gallons Per Minute (gpm) or Liters Per Minute (lpm). Do not confuse the term volume with application rate, which will be covered later.

As pressure increases, the flow volume in a given nozzle also increases. For example, an average size nozzle which discharges 0.52 gpm (1.4 lpm) at 30 psi (2 bar), will discharge 0.73 gpm (2 lpm) at 60 psi (4 bar). In this example, an increase in pressure of 100% has caused an increase in discharge of 40%.

Some nozzles deliver a small volume (for example: 0.2 gpm (0.75 lpm)). Some nozzles deliver a relatively large volume (for example: 1.5 gpm (5.7 lpm)), or $7\frac{1}{2}$ times as much as the smaller nozzle in this example.

The amount of material (volume) to be applied is determined by the effect the chemical has on the turf.

2. The nozzle on a sprayer is to form the liquid into droplets. The size of the droplet is determined by two factors design and system pressure (psi/bar).

Particular applications are done best by big droplets such as systemic fungicides, insecticides and some herbicides in order to reduce drift. Other applications require small droplets like contact fungicides and some herbicides. Again, this is determined by whether the chemical is foliar applied or soil applied. Large droplets for soil applied material, small droplets for foliar applied materials that evenly cover the plant better.

Pressure also affects droplet size. More pressure at the same nozzle produces smaller droplets, more subject to drift. The general rule on pressure is to use the lowest pressure possible with just enough to form adequate spray nozzle patterns.

NOZZLES (CONTINUED)

- Disperse the material in a specific pattern that will insure even distribution of chemical across the swath covered by the boom.

As shown (to the right) the pattern formed by flat fan (TeeJet) nozzles would show most liquid concentrated at the center, then tapering off where it begins to overlap with the next nozzle—approximately $\frac{1}{3}$. The pattern of liquid dispersed by the hollow-cone is more even across its width. Each nozzle overlaps the adjoining nozzle by 100%. That is to say the area covered by each nozzle extends to the center of the two nozzles on either side.

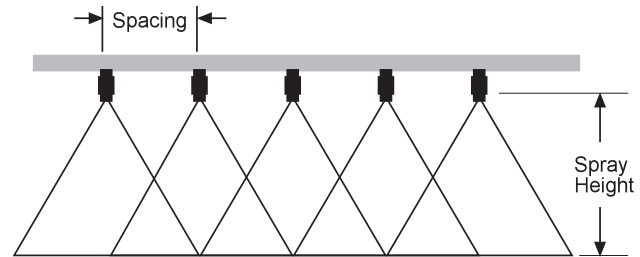

In order to properly develop their spray pattern, each nozzle must be the proper distance from the next nozzle (spacing) and the proper height above the ground.

NOZZLE SCREENS (STRAINERS)

Smaller nozzles require nozzle screens or strainers to prevent clogging.

- Teejet type nozzles size 8001 and 80015 require 100 mesh screens.
- Teejet type nozzles from size 8002 through 8008 require 50 mesh screens.
- Turbo TurfJet Nozzles Size 1/4 TTJ02-VS and larger do not require strainers.
- Turbo Floodjet Nozzles TF-VS2 through TF-VS3 require 50 mesh screens.
- Turbo Floodjet Nozzles TF-VS4 and larger do not require screens.

SPACING

Turf spray nozzles are normally 20" (51 cm) apart. Some cases 40" (101 cm), depending on the type of spray boom and type of area to be sprayed.

Very fine, level areas (golf greens and tees, bowling lawns, tennis courts, etc.) may be sprayed with nozzles spaced every 10" (25 cm).

BOOMHEIGHT

Height is very important in permitting spray nozzles to develop their proper spray pattern. If nozzles are too high, excessive overlap develops. If nozzles are too low, there is not enough overlapping of nozzle spray patterns.

NOZZLE TYPE	NOZZLE SPACING	HEIGHT ABOVE THE GROUND
80° Flat Fan	20" (51 cm)	18" (45 cm)
65° Flat Fan	20" (51 cm)	12" (30 cm)
Turbo TurfJet	20" (51 cm)	15" (38 cm)
Turbo TurfJet	40" (101 cm)	19" (48 cm)
Turbo Floodjet	20" (51 cm)	16" (41 cm)
Turbo Floodjet	40" (100 cm)	18" (45 cm)

Improper nozzle height or spacing prevents proper application of chemical. Some areas are under treated and chemicals are ineffective. Some areas are overtreated with wasted chemical and possible turf damage.

Operating your sprayer at a desired speed and pressure on a hard, dry surface is a good method of checking spraying consistency. Observe nozzles in operation, observe if the area dries evenly. If there are alternating wet and dry streaks, raise or lower the spray boom. If the wet streaks are directly under the nozzle, the boom is too low. If the wet streaks are between the nozzles, the boom is too high.

Calibrating simply means to adjust a set of variables on the sprayer in order to deliver the desired amount of chemical to a known area of turf.

The job of calibrating the sprayer consists of balancing these variables so that your sprayer delivers the desired application rate. That is, an amount of chemical on a given area. It is expressed as:

Gallons Per Acre (gpa) (1 US gpa = 0.83 UK gpa)

or **Gallons Per 1,000 Square Feet (gpt)**

or **Liters Per Hectare (lph)** (1 US gpa = 9.35 lph)

A number of acceptable methods for calibrating a turf sprayer are widely available. The calibration method chosen must take these variables into account. They must include known ground speed (by measurement or from an accurate speedometer) and nozzle output (gpm or lpm) from a nozzle chart or from actual measurement. The variables are:

PRESSURE

Just as pressure increases the volume discharge rate, it also increases the application rate. Pressure must increase by 4 times in order to double the application rate. Small pressure changes of 10 psi (1.4 bar) or less do not greatly affect performance.

Pressure is established and maintained by a pressure control valve or by a flow control valve located on the sprayer.

NOZZLE CAPACITY (VOLUME)

We have covered the different types of spray patterns of various nozzles and made our selection of type accordingly. We now have to choose a size which will provide the correct application rate.

Sizes are available for all requirements. Consult the nozzle chart in this manual for your nozzle type in order to select the correct size.

TRAVEL SPEED

Increased travel speed decreases the application rate (gpa, gpt or lph). Travel speed must be safe and appropriate for the area to be sprayed.

Unlike pressure changes which have only a minor effect on application rate, ground speed changes have a more major and direct effect. For example: 50% decrease in ground speed means a 100% increase in application rate. If the vehicle does not have an accurate speedometer, correct speed must be determined by timing the sprayer travel over a measured distance. (Refer to the page in this manual titled, "Abbreviations and Conversions").

To calibrate a sprayer, the user must:

1. **Understand** the Variables
2. **Set** those variables using one of the proven methods available.
3. **Make** a trial run and measure the output (use water, not chemical).
4. **Determine** the output.
5. **Make** adjustments to the 3 variables until the output is at the desired level.

This covers the principles of what must be known to prepare a sprayer for operation.

IMPORTANT

There are other acceptable and proven methods of calibrating a turf sprayer for application. Other techniques may be more suitable depending on operational needs and technical competence of the operator.

THE NOZZLE CHART METHOD OF CALIBRATION

The Nozzle Chart Method is useful when the sprayer nozzles are new or nearly new. It is also the most useful method to employ when the sprayer is equipped with an Electronic Spray Control System. The Electronic Spray Control System does most of the calibration work, it is up to the operator to select the proper combination of nozzle size and ground speed which will deliver the desired application rate.

The nozzle chart method requires the use of the appropriate nozzle charts which are found in the back of this manual (Nozzle Charts 1 through 8). Nozzle charts for other nozzles are available from the manufacturer.

CALIBRATION STEPS

1. **Determine “HOW”** your sprayer is to be calibrated from the list of variables below.

- a. **Nozzle Type** (Teejet, Turbo Turf, Turbo Flood)
- b. **Spacing** (10" (25 cm) or 20" (51 cm) or 30" (76 cm))
- c. **Expression of Application Rate** (gpa or gpt or lph)

The answers to these three questions will direct you to the appropriate nozzle chart for your application. The correct nozzle chart **MUST** be used.

2. **Determine the Desired Application Rate.**

This is determined from the information on chemical labels or other technical information available from a variety of sources.

3. **Determine an Acceptable Ground Speed.**

Conditions over which the sprayer will operate generally dictate the appropriate ground speed. Within the limits of practicality and efficiency, spraying should generally be done at lowest possible speed. This increases operator safety and contributes to more precise application of chemicals. For example, golf greens and tees and hill areas would generally be sprayed in the range of 2¹/₂ to 3¹/₂ mph (4-6 kph). Larger, open and more level areas such as golf fairways and park or school grounds would be sprayed at 4¹/₂ to 6 mph (7-10 kph).

The vehicle which carries or tows the sprayer should be equipped with a precise low-speed speedometer. If it is not, exact ground speed at a given engine speed must be determined by timing the travel of the sprayer over a measured distance.

4. **Determine Nozzle Size.**

Refer to the appropriate nozzle chart in the back of this manual for your nozzle TYPE (the type of nozzle you have or type you wish to use), nozzle SPACING and CALIBRATION TYPE (gpm, gpt or lph).

You will note from the chart, that application rates from any given nozzle decrease as the ground speed increases. In other words, the faster you drive, the less material you are applying.

Application rates are shown in the columns to the right of the charts. Once the desired application rate is decided upon, it should be located, as nearly as possible in one of these columns on the appropriate chart for your operation. It could well be that the approximate rate desired would be obtained from the nozzles already installed in the boom. If this is not possible, then nozzles will need to be changed.

IMPORTANT

When selecting a new nozzle size refer to the “Discharge Rate Column” on the nozzle charts. The Discharge Rate (gpm or lpm) multiplied by the number of nozzles should not exceed 75% of the actual discharge volume of the sprayer pump. [i.e., if you need to use nozzles which discharge 0.8 gpm (3.0 lpm), and the spray boom is equipped with 12 nozzles, the sprayer pump would have to produce an actual discharge volume of 13 gpm (49 lpm) in order to properly supply these nozzles.] If the collective volume of the spray boom nozzles exceeds the actual discharge volume of the pump, inadequate pressure and poor nozzle distribution patterns may result.

Once nozzle type and size have been determined, those nozzles are installed in the sprayer boom. Nozzles should be expected to be replaced after 15-20 hours of actual sprayer operation. After nozzles are installed, make trial application of water over a known area to check application rate.

THE NOZZLE CHART METHOD OF CALIBRATION

5. For Sprayer with Electronic Spray Control Systems.

On sprayers equipped with Electronic Spray Control Systems such as those manufactured by Raven Ind., Micro-Trak Co. and Dickey-John Co., it is still important to select the right type and size of nozzle for the required operation. Electronic Spray Control Systems cannot function properly if the nozzles are not capable of delivering the programmed (desired) application rate. Nozzles which are too large will not develop adequate pressure or satisfactory spray patterns. Nozzles which are too small will not allow the discharge of spray material at the programmed application rate.

Further, when calibrating sprayers which are equipped with Electronic Spray Control Systems, care must be taken to use the mode of operation on the Spray Control System (Gallons per acre "US" Mode); Gallons per 1,000 Square Feet ("Turf" Mode); or Liters per Hectare (Standard International Model), which corresponds with the nozzle calibration charts (gpa, gpt or lph).

6. Using the Nozzle Charts.

Select the correct chart based on your nozzle type, nozzle spacing and desired expression of application rate (gpa, gpt or lph). If the desired operating speed is not found on the nozzle chart, it is simple to determine application rate at different speeds by estimating from the known facts.

Example 1: If the desired speed is 2½ MPH (4 kph) on a sprayer using TurfJet nozzles (Chart 5). The average between the application rates for 2 MPH and 3 MPH may be assumed to be the application rate for 2½ MPH.

Example 2: The desired speed is 6 MPH. Use the application rate column for 3 MPH a divide by 2.

7. Converting Nozzle Chart Method to British Gallons.

To convert any of the Gallon Per Acre rates to Imperial Gallons per acre, (Imp gpa) multiply by 0.83. To convert any of the Liter Per Hectare rates to Imperial Gallons Per Hectare (Imp GPH), multiply by 0.22.

8. Checking the Actual Application Rate.

After the combination of ground speed, nozzle size and operating pressure has been selected, the sprayer should be operated with water only to determine if the target application rate is achieved.

THE "128" METHOD OF BOOM SPRAYER CALIBRATION

The "128" Method is useful for calibrating sprayers and also for checking the calibration of sprayer calibrated by the Nozzle Chart Method and sprayers using Electronic Spray Control Systems. The "128" is based on a convenient mathematical relationship that exists between US Gallons, liquid ounces and acres.

An ounce is 1/128th of a (US) gallon. If an area which was "1/128th of an acre" could be found, the number of ounces applied to that small area would be equal to the number of gallons applied to the acre. Thus, no mathematical computations would be required.

To determine an area which is 1/128 of an acre:

- On nozzles with 20 inch (51 cm) spacing, measure off a distance of 204 ft (62 meters). Mark a "START" and a "STOP" line. The rectangle formed by this distance and the spraying width of one nozzle 20" (51 cm) is equal to 340 square feet which is equal to 1/128 acre. Therefore, the amount of material applied to this area by one nozzle in OUNCES is the same amount of material applied to an acre in GALLONS (gpa).
- On nozzles with 10 inch (25 cm) spacing, the measure distance is 408 feet (124 meters).
- On nozzles with 30 inch (76 cm) spacing the measured distance is 136 feet (41 meters).

CALIBRATING FOR APPLICATION

1. Fill the sprayer tank with water. Run the sprayer, inspect it for leaks and make sure all systems function properly.
2. Drive the sprayer through the measured distance discussed above at normal spraying speed, record the travel time required to cover the measured distance in seconds with a stopwatch.

PARTS MANUALS AVAILABLE ONLINE AT smithco.com



THE "128" METHOD OF BOOM SPRAYER CALIBRATION

The carrying or towing vehicle is to be traveling at the desired speed when it crosses the start line of the measured course.

Repeat this procedure and determine the average of the two times.

3. With the sprayer parked, run the sprayer at the required pressure level. Catch the output of each nozzle in a container which is marked or graduated in Ounces for the exact same period of time which it took the sprayer to cover the measured course in step #2. It is necessary to operate the vehicle engine at spraying speed using a hand throttle.
4. Observe the volume of water in the collection bottle. The number of OUNCES collected in the time it takes to cover the marked course. Take the average nozzle output by adding the outputs of each nozzle and then dividing that sum by the number of nozzles.

The NUMBER OF OUNCES collected in the time required to cover the SMALL AREA is equal to the NUMBER OF GALLONS applied per ACRE. For example: if an average of 40 ounces of water is collected in the time required to cover the 1/128 acre area, the application rate is 40 gallons per acre (gpa).

▲ IMPORTANT

As a practical matter, if high application rates are desired (above 75 gpa), the measured course length should be reduced by half (i.e. 102 ft (31 m) for 20 inch (52 cm) spaced nozzles). The volume collected (above) is then doubled (multiplied by 2).

AVERAGE OUTPUT (Ounces) = APPLICATION RATE (gpa)

5. Observe individual nozzle output volumes. If an individual nozzle is 10% above or below the average output, check for blockages in the nozzle or in the nozzle strainer. If the nozzle is worn or damaged, replace it.
6. Compare this actual application rate with the recommended rate. If the actual rate is more than 5% higher or lower than the intended rate, adjustments must be made.
7. Minor adjustments in application rate may be made by increasing or decreasing the spraying pressure. Lowering spraying pressure decreases application rate. Increasing spraying pressure increases application rate. This procedure normally does not apply to spray systems controlled by an Electronic Spray Control System, which governs flow rate.
8. Adjustments in application rate may be made by increasing or decreasing the travel speed of the sprayer if conditions permit. Slower speeds increase application rate. Faster speeds decrease application rate.
9. Nozzle sizes can be changed to provide the correct application rate. Refer to the nozzle charts in this book for the desired nozzle type.
10. Re-calibrate the sprayer (steps 2-6) after any adjustments are made.

As previously discussed, there are other acceptable methods of Turf Sprayer Calibration. Chemical suppliers, Agricultural Extension Agents, Universities and consultants of various types offer helpful advice on this subject. Technical catalogues are available from nozzle manufacturers.

TRANSFERRING THE "128" METHOD INTO METRIC (LITERS PER HECTARE)

The same steps are used that are used when calibrating in gallons per acre. First a relationship between a measurable amount (milliliters) and the calibration amount (liter) is determined. That ratio is 1:1000.

Now an area which is 1/1000th of a hectare must be measured.

On spray booms with 51 cm (20 inch) spacing, mark off an area which is 20 meters (65.6 feet) long. The area formed by that length and the width of one spray nozzle (20 meters by 0.5 meters) is 10 square meters which is 1/1000 of a hectare. Therefore, the amount of spray material applied to this small area in milliliters is equal to the amount applied to one hectare in liters.

Then, follow the remaining steps 2-10, substituting milliliters for ounces, liters for gallons, square meters for square feet and hectares for acres.

AVERAGE OUTPUT (Milliliters) = APPLICATION RATE (LITERS/HECTARE)



NOZZLE PERFORMANCE CHART #1

Nozzle Type:		XR TeeJet & DG TeeJet									
Spacing:		20 inch (51cm)									
Calibration:		US Gal/Acre (GPA) & US Gal/1,000 Square Feet (GPT)									
Color	Size	Pressure psi	Nozzle Capacity (Gal/Min)	Application Rate GPA Speed MPH				Application Rate GPT Speed MPH			
				4	5	6	7	2	3	4	5
Orange	X11001	20	0.071	5.3	4.2	3.5	3.0	0.24	0.16	0.12	0.10
		30	0.087	6.5	5.2	4.3	3.7	0.31	0.21	0.16	0.11
		40	0.10	7.4	5.9	5.0	4.2	0.34	0.23	0.17	0.14
		60	0.12	8.9	7.1	5.9	5.1	0.41	0.28	0.21	0.16
Green	XR110015 DG11001 5	20	0.11	8.2	6.5	5.4	4.7	0.38	0.25	0.19	0.15
		30	0.13	9.7	7.7	6.4	5.5	0.44	0.30	0.22	0.18
		40	0.15	11.1	8.9	7.4	6.4	0.51	0.34	0.26	0.20
		60	0.18	12.6	10.7	8.9	7.6	0.61	0.41	0.31	0.25
Yellow	XR11002 DG11002	20	0.14	10.4	8.3	6.9	5.9	0.48	0.32	0.24	0.19
		30	0.17	12.6	10.1	8.4	7.2	0.58	0.39	0.29	0.23
		40	0.20	14.96	11.9	9.9	8.5	0.68	0.45	0.34	0.27
		60	0.24	17.8	13.1	11.9	10.2	0.82	0.54	0.41	0.33
Blue	XR11003 DG11003	20	0.21	15.6	12.5	10.4	8.9	0.72	0.48	0.36	0.29
		30	0.26	19.3	15.4	12.9	11.0	0.89	0.59	0.44	0.35
		40	0.30	22.0	17.8	14.9	12.7	1.02	0.68	0.51	0.41
		60	0.37	27.0	22.0	18.3	15.7	1.26	0.84	0.63	0.50
Red	XR11004 DG11004	20	0.28	21.0	16.6	13.9	11.9	0.98	0.64	0.48	0.38
		30	0.35	26.0	21.0	17.3	14.9	1.20	0.80	0.60	0.48
		40	0.40	30.0	24.0	19.8	17.0	1.40	0.91	0.68	0.55
		60	0.49	36.0	29.0	24.0	21.0	1.70	1.10	0.84	0.67
Brown	XR11005 DG11005	20	0.35	26.0	21.0	17.3	14.9	1.20	0.80	0.60	0.48
		30	0.43	32.0	26.0	21.0	18.2	1.50	0.98	0.73	0.59
		40	0.50	37.0	30.0	25.0	21.0	1.70	1.10	0.85	0.68
		60	0.61	45.0	36.0	30.0	26.0	2.10	1.40	1.00	0.83
Gray	XR11006	20	0.42	31.0	25.0	21.0	17.8	1.40	0.95	0.72	0.57
		30	0.52	39.0	31.0	26.0	22.0	1.80	1.20	0.89	0.57
		40	0.60	45.0	36.0	30.0	25.0	2.00	1.40	1.00	0.82
		60	0.73	54.0	43.0	36.0	31.0	2.50	1.70	1.20	0.99
White	XR11008	20	0.57	42.0	34.0	28.0	24.0	1.90	1.30	0.97	0.78
		30	0.69	51.0	41.0	34.0	29.0	2.40	1.60	1.20	0.94
		40	0.80	59.0	48.0	40.0	34.0	2.70	1.80	1.40	1.10
		60	0.98	73.0	58.0	49.0	42.0	3.30	2.20	1.70	1.30
Steel	SS11010	40	1.00	128	74.0	59.0	50.0	3.40	2.30	1.70	1.40
		60	1.20	156	91.0	72.0	60.0	4.10	2.80	2.10	1.70

NOZZLE PERFORMANCE CHART #2

Nozzle Type: Spacing: Calibration:		XR TeeJet & DG TeeJet 20 inch (51cm) Liters Per hectare									
Color	Size	Pressure bar	Nozzle Capacity (l/min)	Application Rate l/ha Speed km/h							
				4	5	6	7				
Orange	X11001	1.5	0.28	84	67.2	56.0	48.0				
		2.0	0.32	96	76.8	64.0	54.9				
		3.0	0.39	117	93.6	78.0	66.9				
		4.0	0.45	135	108	90.0	77.1				
Green	XR110015 DG11001 5	1.5	0.42	126	101	84.0	72.0				
		2.0	0.48	144	115	96.0	82.3				
		3.0	0.59	177	142	118	101				
		4.0	0.68	204	163	136	117				
Yellow	XR11002 DG11002	1.5	0.56	168	134	112	96.0				
		2.0	0.65	195	156	130	111				
		3.0	0.79	237	190	158	135				
		4.0	0.91	273	218	182	156				
Blue	XR11003 DG11003	1.5	0.83	249	199	166	142				
		2.0	0.96	288	230	192	165				
		3.0	1.18	354	283	236	202				
		4.0	1.36	408	326	272	233				
Red	XR11004 DG11004	1.5	1.12	336	269	224	192				
		2.0	1.29	387	310	258	221				
		3.0	1.58	474	379	316	271				
		4.0	1.82	546	437	364	312				
Brown	XR11005 DG11005	1.5	1.39	417	334	278	238				
		2.0	1.61	483	386	322	276				
		3.0	1.97	591	473	394	338				
		4.0	2.27	681	545	454	389				
Gray	XR11006	1.5	1.68	504	403	336	288				
		2.0	1.94	582	466	388	333				
		3.0	2.37	711	569	474	406				
		4.0	2.74	822	658	548	470				
White	XR11008	1.5	2.23	669	535	446	382				
		2.0	2.58	774	619	516	442				
		3.0	3.16	948	758	632	542				
		4.0	3.65	1095	876	730	626				
Steel	SS11010	3.0	3.95	1185	948	790	677				
		4.0	4.56	1368	1094	912	782				

NOZZLE PERFORMANCE CHART #3

Nozzle Type:		Turbo FloodJet									
Spacing:		40 inch (100cm)									
Calibration:		US Gal/Acre (GPA) & US Gal/1,000 Square Feet (GPT)									
Color	Size	Pressure psi	Nozzle Capacity (Gal/Min)	Application Rate GPA				Application Rate GPT			
				Speed MPH				Speed MPH			
				4	5	6	7	4	5	6	7
Red	TF-VS2	20	0.28	10.4	8.3	6.9	5.9	.24			
		30	0.35	13.0	10.4	8.7	7.4	.30			
Brown	TF-VS2.5	20	0.35	13.0	10.4	8.7	7.4	.30			
		30	0.43	16.0	12.8	10.6	9.1	.37			
Gray	TF-VS3	20	0.42	15.6	12.5	10.4	8.9	.36			
		30	0.52	19.3	15.4	12.9	11.0	.44			
White	TF-VS4	20	0.57	21.0	16.9	14.1	12.1	.48			
		30	0.69	26.0	20.0	17.1	14.6	.59			
Blue	TF-VS5	20	0.71	26.0	21.0	17.6	15.1	.60			
		30	0.87	32.0	26.0	22.0	18.5	.74			
Green	TF-VS7.5	20	1.06	39.0	31.0	26.0	22.0	.90			
		30	1.30	48.0	39.0	32.0	28.0	1.11			
Black	TF-VS10	20	1.41	52.0	42.0	35.0	30.0	1.20			
		30	1.73	64.0	51.0	43.0	37.0	1.47			

NOZZLE PERFORMANCE CHART #4

Nozzle Type: Spacing: Calibration:		Turbo FloodJet 40 inch (100cm) Liters Per Hectare									
Color	Size	Pressure bar	Nozzle Capacity (l/min)	Application Rate l/ha Speed km/h				Application Rate GPT Speed MPH			
				4	6	8	10				
Red	TF-VP2	1.5	1.11	167	111	83.3	66.6				
		2.0	1.29	194	129	96.8	77.4				
Brown	TF-VP2.5	1.5	1.40	210	140	105	84.0				
		2.0	1.61	242	161	121	96.6				
Gray	TF-VP3	1.5	1.68	252	168	126	101				
		2.0	1.94	291	194	146	116				
White	TF-VP4	1.5	2.23	335	223	167	112				
		2.0	2.57	386	257	193	129				
Blue	TF-VP5	1.5	2.79	419	279	209	167				
		2.0	3.22	483	322	242	193				
Green	TF-VP7.5	1.5	4.19	629	419	314	251				
		2.0	4.83	726	484	363	290				
Black	TF-VP10	1.5	5.58	837	558	419	335				
		2.0	6.45	968	645	484	387				

NOZZLE PERFORMANCE CHART #5



Nozzle Type:		Turbo TurfJet									
Spacing:		20 inch (51cm)									
Calibration:		US Gal/Acre (GPA) & US Gal/1,000 Square Feet (GPT)									
Color	Size	Pressure psi	Nozzle Capacity (Gal/Min)	Application Rate GPA Speed MPH (KPH)				Application Rate GPT Speed MPH (KPH)			
				3 (5)	4 (6)	5 (8)	6 (10)	3 (5)	4 (6)	5 (8)	6 (10)
Yellow	1/4 TTJ02-VS	25	.16	15.8	11.9	9.5	7.9	.36	.27	.22	.18
		30	.17	16.8	12.6	10.1	8.4	.39	.29	.23	.19
		40	.20	19.8	14.9	11.9	9.9	.45	.34	.27	.23
		50	.22	22	16.3	13.1	10.9	.50	.37	.30	.25
Red	1/4 TTJ04-VS	25	.32	32	24	19.0	15.8	.73	.54	.44	.36
		30	.35	35	26	21	17.3	.79	.60	.48	.40
		40	.40	40	30	24	19.8	.91	.68	.54	.45
		50	.45	45	33	27	22	1.0	.77	.61	.51
Brown	1/4 TTJ05-VS	25	.40	40	30	24	19.8	.91	.68	.54	.45
		30	.43	43	32	26	21	.97	.73	.58	.49
		40	.50	50	37	30	25	1.1	.85	.68	.57
		50	.56	55	42	33	28	1.3	.95	.76	.63
Gray	1/4 TTJ06-VS	25	.47	47	35	28	23	1.1	.80	.64	.53
		30	.52	51	39	31	26	1.2	.88	.71	.59
		40	.60	59	45	36	30	1.4	1.0	.82	.68
		50	.67	66	50	40	33	1.5	1.1	.91	.76
White	1/4 TTJ08-VS	25	.63	62	47	37	31	1.4	1.1	.86	.71
		30	.69	68	41	41	34	1.6	1.2	.94	.78
		40	.80	79	59	48	40	1.8	1.4	1.1	.91
		50	.89	88	66	53	44	2.0	1.5	1.2	1.0
L. Blue	1/4 TTJ10-VS	25	.79	78	59	47	39	1.8	1.3	1.1	.90
		30	.87	86	65	52	43	2.0	1.5	1.2	.99
		40	1.00	99	74	59	50	2.3	1.7	1.4	1.1
		50	1.12	111	83	67	55	2.5	1.9	1.5	1.3
L. Green	1/4 TTJ15-VS	25	1.19	118	88	71	59	2.7	2.0	1.6	1.3
		30	1.30	129	97	77	64	2.9	2.2	1.8	1.5
		40	1.50	149	111	89	74	3.4	2.6	2.0	1.7
		50	1.68	166	125	100	83	3.8	2.9	2.3	1.9

NOZZLE PERFORMANCE CHART #6

Nozzle Type: Spacing: Calibration:		Turbo TurfJet 20 inch (51cm) Liters Per Hectare									
Color	Size	Pressure bar	Nozzle Capacity (l/min)	Application Rate l/ha Speed KPH (MPH)							
				4 (2.5)	6 (4)	8 (5)	10 (6)				
Yellow	1/4 TTJ02-VP	1.0	0.46	69.0	46.0	34.5	27.6				
		1.5	0.56	84.0	56.0	42.0	33.6				
		2.0	0.65	97.5	65.0	48.8	32.5				
		3.0	0.80	120.0	80.0	60.0	48.0				
Red	1/4 TTJ04-VP	1.0	.091	137	91.0	68.3	54.6				
		1.5	1.11	167	111	83.3	66.6				
		2.0	1.29	194	129	95.8	77.4				
		3.0	1.58	237	158	119	94.8				
Brown	1/4 TTJ05-VP	1.0	1.14	171	114	85.5	68.4				
		1.5	1.40	210	140	105	84.0				
		2.0	1.61	242	161	121	96.6				
		3.0	1.97	296	197	148	118				
Gray	1/4 TTJ06-VP	1.0	1.37	206	137	103	82.2				
		1.5	1.68	252	168	126	101				
		2.0	1.94	291	194	146	116				
		3.0	2.37	356	237	178	142				
White	1/4 TTJ08-VP	1.0	1.82	273	182	137	109				
		1.5	2.23	335	223	167	134				
		2.0	2.57	385	257	193	154				
		3.0	3.15	473	315	236	189				
L. Blue	1/4 TTJ10-VP	1.0	2.28	342	228	171	137				
		1.5	2.79	419	279	209	167				
		2.0	3.22	483	322	242	193				
		3.0	3.95	593	395	295	237				
L. Green	1/4 TTJ15-VP	1.0	3.42	513	342	257	205				
		1.5	4.19	629	419	314	251				
		2.0	4.84	726	484	363	290				
		3.0	5.92	888	592	444	355				

DECLARATION OF CONFORMITY • ДЕКЛАРАЦИЯ ЗА СЪОТВЕТСТВИЕ • PROHLÁŠENÍ O SHODĚ • OVERENSSTEMMELSESERKLÆRING • CONFORMITEITSVERKLARING • VASTAVUSDEKLARATSIOON • VAATIMUSTENMUKAISUUSVAKUUTUS • DECLARATION DE CONFORMITE • KONFORMITÄTSEKHLÄRUNG • ΔΗΛΩΣΗ ΣΥΜΜΟΡΦΩΣΗΣ • MEGFELELŐSÉGI NYILATKOZAT • DICHIARAZIONE DI CONFORMITÀ • ATBILSTĪBAS DEKLARĀCIJA • ΑΤΙΤΙΚΤΙΕΣ ΔΕΚΛΑΡΑΚΙJA • DIKJARAZZJONI TAL-KONFORMITÀ • DEKLARACIA ZGDNOŚCI • DECLARAÇÃO DE CONFORMIDADE • DECLARAȚIE DE CONFORMITATE • VYHLÁSENIE O ZHODE • IZJAVA O SKLADNOSTI • DECLARACIÓN DE CONFORMIDAD • DEKLARATION OM ÖVERENSSTÄMMELSE

Business name and full address of the manufacturer • Търговско име и пълен адрес на производителя • Obchodní jméno a plná adresa výrobce • Producentens firmanavn og fulde adresse • Bedrijfsnaam en volledige adres van de fabrikant • Tootja ärinimi ja täielik aadress • Valmistajan toiminimi ja täydellinen osoite • Nom commercial et adresse complète du fabricant • Firmenname und vollständige Adresse des Herstellers • Εταιρική και ταχυδρομική διεύθυνση κατασκευαστή • A gyártó üzleti neve és teljes címe • Ragione sociale e indirizzo completo del fabbricante • Uzpěmuma nosaukums un pilna ražotāja adrese • Verslo pavadinimas ir pilnas gamintojo adresas • Isem kummerčjali u indirizz shih tal-fabrikant • Nazwa firmy i pełny adres producenta • Nome da empresa e endereço completo do fabricante • Denumirea comercială și adresa completă a producătorului • Obchodný názov a úplná adresa výrobcu • Naziv podjetja in polni naslov proizvajalca • Nombre de la empresa y dirección completa del fabricante • Tillverkarens företagsnamn och kompletta adress	Smithco Inc. 34 West Avenue Wayne, PA USA 19087-3311
Product Code • Код на продукта • Kód výrobku • Produktkode • Productcode • Toote kood • Tuotekoodi • Code produit • Produktcode • Κωδικός προϊόντος • Termékkód • Codice prodotto • Produkta kods • Produktu kods • Kodici tal-Prodott • Kod produktu • Código do Produto • Cod produs • Kód výrobku • Oznaka proizvoda • Código de producto • Produktkod	20-500
Machine Name • Наименование на машината • Název stroje • Maskinnavn • Machinenavn • Masina nimi • Laitteen nimi • Nom de la machine • Maschinenbezeichnung • Ονομασία μηχανήματος • Gépnév • Denominazione della macchina • Iekārtas nosaukums • Mašinos pavadinimas • Isem tal-Magna • Nazwa urzędzenia • Nome da Máquina • Numele echipamentului • Názov stroja • Naziv stroja • Nombre de la máquina • Maskinens namn	Spray Star 2000
Designation • Предназначение • Označení • Betegnelse • Benaming • Nimetus • Түппимеркintä • Pažymėjimas • Bezeichnung • Χαρακτηρισμός • Megnevezés • Funzione • Apzīmējums • Lithuanian • Denominazzjoni • Oznaczenie • Designação • Specificație • Označenie • Namen stroja • Descripción • Beteckning	Turf Sprayer
Serial Number • Серийн номер • Sériové číslo • Seriennummer • Seriennummer • Seerianumber • Valmistusnumero • Numéro de série • Seriennummer • Σειριακός αριθμός • Sorozatszám • Numero di serie • Sērijas numurs • Serijos numeris • Numru Serjali • Numer serjyny • Número de Série • Număr de serie • Sériové číslo • Serijska številka • Número de serie • Seriennummer	200G101
Engine • Двигател • Motor • Motor • Motor • Mootor • Mootori • Moteur • Motor • Μηχανή • Modulnėv • Motore • Dzinējs • Variklis • Sahha Netta Installata • Silnik • Motor • Motor • Motor • Motor • Motor • Motor	Briggs & Stratton 543477
Net Installed Power • Нетна инсталирана мощност • Čistý inštalovaný výkon • Installeret nettoeffekt • Netto ge installeerd vermogen • Installeeritud netovõimsus • Asennettu nettoteho • Puissance nominale nette • Installierte Nettoleistung • Καθαρή εγκατεστημένη ισχύς • Nettó beépített teljesítmény • Potenza netta installata • Paredzētā tīkla jauda • Grynoji galia • Wisa' tal-Qutgh • Moc zainstalowana netto • Potência instalada • Puterea instalată netă • Čistý inštalovaný výkon • Neto vgrajena moč • Potencia instalada neta • Nettoeffekt	23 kW
Conforms to Directives • В съответствие с директивите • Splňuje podmínky směrníc • Er i overensstemmelse med direktiver • Voldoet aan de richtlijnen • Vastab direktiividele • Direktiiven mukainen • Conforme aux directives • Entspricht Richtlinien • Ακολουθείτε πιστά τις Οδηγίες • Megfelel az irányelveknek • Conforme alle Direttive • Atbilst direktīvām • Atitinka direktyvų reikalavimus • Valutazzjoni tal-Konformità • Dyrektywy związane • Cumpre as Directivas • Respectă Directivele • Je v súlade so smernicami • Skladnost z direktivami • Cumpre con las Directivas • Uppfyller direktiv	2006/42/EC; 2000/14/EC Annex VI . Part 1
Conformity Assessment • Оценка за съответствие • Hodnocení plnění podmínek • Överensstemmelsesvurdering • Conformiteitsbeoordeling • Vastavushindamine • Vaatimustenmukaisuuden arviointi • Evaluation de conformité • Konformitätsbeurteilung • Διαπίστωση Συμμόρφωσης • Megfelelőség-értékelés • Valutazione della conformità • Atbilstības novērtējums • Atitiktības įvertinimas • Livell tal-Qawwa tal-Foss Imkejjel • Ocena zgodności • Avaliação de Conformidade • Evaluarea conformității • Vyhodnotenie zhodnosti • Ocena skladnosti • Evaluación de conformidad • Bedömning av överensstämmelse	2006/42/EC Annex VIII
Measured Sound Power Level • Измерено ниво на звукова мощност • Naměřený akustický výkon • Målte lydstrykeniveau • Gemeten geluidsniveau • Mõõdetud helivõimsuse tase • Mitattu äänitehotaso • Niveau de puissance sonore mesuré • Gemessener Schalldruckpegel • Σταθμισμένο επίπεδο ηχητικής ισχύος • Mért hangteljesítményszint • Livello di potenza sonora misurato • Izm ārtais skaņas jaudas līmenis • Išmatuotas garso stiprumo lygis • Livell tal-Qawwa tal-Foss Iggarantit • Moc akustyczna mierzona • Nivel sonoro medido • Nivelul măsurat al puterii acustice • Nameraná hladina akustického výkonu • Izmerjena raven zvočne moči • Nivel de potencia sonora medido • Uppmätt ljudeffektsnivå	84dB(A)Lwa
Guaranteed Sound Power Level • Гарантирано ниво на звукова мощност • Garantovaný akustický výkon • Garanteret lydstrykeniveau • Gearandeerd geluidsniveau • Garanteeritud helivõimsuse tase • Taattu äänitehotaso • Niveau de puissance sonore garanti • Garantierter Schalldruckpegel • Εγγυημένο επίπεδο ηχητικής ισχύος • Szavatolt hangteljesítményszint • Livello di potenza sonora garantito • Garant étais skaņas jaudas līmenis • Garantuotas garso stiprumo lygis • Livell tal-Qawwa tal-Foss Iggarantit • Moc akustyczna gwarantowana • Nivel sonoro farrantido • Nivelul garantat al puterii acustice • Garantovaná hladina akustického výkonu • Zajamčena raven zvočne moči • Nivel de potencia sonora garantizado • Garanterad ljudeffektsnivå	86 dB(A)Lwa
Conformity Assessment Procedure (Noise) • Оценка за съответствие на процедурата (Шум) • Postup hodnocení plnění podmínek (hluk) • Procedure for overensstemmelsesvurdering (Støj) • Procedure van de conformiteitsbeoordeling (geluid) • Vastavushindamismenetlus (müra) • Vaatimustenmukaisuuden arviointimenetely (Melu) • Procédure d'évaluation de conformité (bruit) • Konformitätsbeurteilungsverfahren (Geräusch) • Διαδικασία Αξιολόγησης Συμμόρφωσης (Οόρυθος) • Megfelelőség-értékelési eljárás (Zaj) • Procedura de valutatezione della conformità (rumore) • Atbilstības novērtējuma procedūra (troksnis) • Atitiktības įvertinimo procedūra (garsas) • Procedura tal-Valutazzjoni tal-Konformità (Hoss) • Procedura oceny zgodności (poziom hałas) • Processo de avaliação de conformidade (nivel sonoro) • Procedura de evaluare a conformității (zgomot) • Postup vyhodnocovania zhodnosti (hluk) • Postopek za ugotavljanje skladnosti (hrup) • Procedimiento de evaluación de conformidad (ruido) • Procedur för bedömning av överensstämmelse (buller)	2000/14/EC Annex VI Part 1
UK Notified Body for 2000/14/EC • Нотифициран орган в Обединеното кралство за 2000/14/EO • Úřad certifikovaný podle směrnice č. 2000/14/EC • Det britiske bemyndigede organ for 2001/14/EF • Engels adviesorgaan voor 2000/14/EG • Ühendkuningriigi teavitatud asutus direktiivi 2000/14/EÜ mõistes • Direktiivin 2000/14/EY mukainen ilmoitettu tarkastuslaitos Iossaa-Britanniassa • Organisme notifié concernant la directive 2000/14/CE • Britische benannte Stelle für 2000/14/EG • Κοινοποιημένος Οργανισμός Ηνωμένου Βασιλείου για 2000/14/EK • 2000/14/EK – egyesült királyságbeli bejelentett szervezet • Organismo Notificato in GB per 2000/14/CE • 2000/14/EK AK re gistrētā organizācija • JK notifikotošos iestaigos 2000/14/EC • Korp Notifikat tar-Renju Unit ghal 2000/14/KE • Dopuszczona jednostka badawcza w Wielkiej Brytanii wg 2000/14/WE • Entidade notificada no Reino Unido para 2000/14/CE • Organism notificat în Marea Britanie pentru 2000/14/CE • Notifikovaný orgán Spojeného královstva pre smernicu 2000/14/ES • Britanski prijavljeni organ za 2000/14/ES • Cuerpo notificado en el Reino Unido para 2000/14/CE • Anmält organ för 2000/14/EG i Storbritannien	Smithco West Inc. 200 West Poplar Avenue Cameron, WI 54822 USA
Operator Ear Noise Level • Оператор на нивото на доловим от ухото шум • Hladina hluku v oblasti uší operátora • Støjniveau i førers ørehøjde • Geluidsniveau oor bestuurder • Műratase operátori k őrvnas • Melutaso käyttäjän korvan kohdalla • Niveau de bruit à hauteur des oreilles de l'opérateur • Schallpegel am Bedienerohr • Επίπεδο θορύβου σε λειτουργία • A kezelő fülénél mért zajszint • Livello di potenza sonora all'orecchio dell'operatore • Trokšņa līmenis pie operatora auss • Dirbančiojo su mašina patiriamio triukšmo lygis • Livell tal-Foss fil-Widna tal-Operatur • Dopuszczalny poziom hałasu dla operatora • Nivel sonoro nos ouvidos do operador • Nivelul zgomotului la urechea operatorului • Hladina hluku pősobnaca na sluch operátora • Raven hrupa pri ušesu upravljavca • Nivel sonoro en el odo del operador • Ljudnivå vid förarens öra	96 dB(A)Lwa (2006/42/EC)

<p>Harmonised standards used • Използвани хармонизирани стандарти • Použité harmonizované normy • Brugte harmoniserede standarder • Gebruikte geharmoniseerde standaards • Kasutatud ühtlustatud standardid • Käytetyt yhdenmukaistetut standardit • Normes harmonisées utilisées • Angewandte harmonisierte Normen • Ευαρμοσμένα πρότυπα που χρησιμοποιήθηκαν • Harmonizált szabványok • Standard armonizzati applicati • Izmanotie saskapote standarti • Panaudoti suderinti standartai • Standards armonizzati usati • Normy spójne powiązane • Normas harmonizadas usadas • Standardele armonizate utilizate • Použité harmonizované normy • Uporabljeni usklajeni standardi • Estándares armonizados utilizados • Harmoniserade standarder som används</p>	<p>BS EN ISO 12100-1:2003 BS EN ISO 12100-2:2003 BS EN ISO 13857 BS EN 349:1993+A1:2008 BS 6356: P8 BS 6356: P5 BS EN 907</p>
<p>Technical standards and specifications used • Използвани технически стандарти и спецификации • Použité technické normy a specifikace • Brugte tekniske standarder og specifikationer • Gebruikte technische standaards en specificaties • Kasutatud tehnilised standardid ja spetsifikatsioonid • Käytetyt tekniset standardit ja eritelmät • Spécifications et normes techniques utilisées • Angewandte technische Normen und Spezifikationen • Τεχνικά πρότυπα και προδιαγραφές που χρησιμοποιήθηκαν • Műszaki szabványok és specifikációk • Standard tecnici e specifiche applicati • Izmanotie tehnicke standarti un specificācijas • Panaudoti techniniai standartai ir techninė informacija • Standards u specifikacijonijiet tehniki užati • Normy i specyfikacje techniczne powiązane • Normas técnicas e especificações usadas • Standardele tehnice și specificațiile utilizate • Použité technické normy a špecifikácie • Uporabljeni tehnični standardi in specifikacije • Estándares y especificaciones técnicas utilizadas • Tekniska standarder och specifikationer som används</p>	<p>ISO 21299 2002/44/EC SAE J1362</p>
<p>The place and date of the declaration • Място и дата на декларацията • Misto a datum prohlášení • Sted og dato for erklæringen • Plaats en datum van de verklaring • Deklaratsiooni väljastamise koht ja kuupäev • Vakutuksen paikka ja päivämäärä • Lieu et date de la déclaration • Ort und Datum der Erklärung • Τόπος και ημερομηνία δήλωσης • A nyilatkozat kelle (hely és idő) • Luogo e data della dichiarazione • Deklarācijas vieta un datums • Deklarācijas vieta ir data • Il-post u d-data tad-dikjarazzjoni • Miejsce i data wystawienia deklaracji • Local e data da declaração • Locul și data declarației • Miesto a dátum vyhlásenia • Kraj in datum izjave • Lugar y fecha de la declaración • Plats och datum för deklarationen</p>	<p>Smithco West Inc. 200 West Poplar Avenue Cameron, WI 54822 USA 24-Jun -09</p>
<p>Signature of the person empowered to draw up the declaration on behalf of the manufacturer, holds the technical documentation and is authorised to compile the technical file, and who is established in the Community. Подпис на човека, упълномощен да състави декларацията от името на производителя, който поддържа техническата документация и е оторизиран да изготви техническия файл и е регистриран в общността. Podpis osoby oprávněné sestavit prohlášení jménem výrobce, držet technickou dokumentaci a osoby oprávněné sestavit technické soubory a založené v rámci Evropského společenství. Underskrift af personen, der har fuldmagt til at udarbejde erklæringen på vegne af producenten, der er indehaver af dokumentationen og er bemyndiget til at udarbejde den tekniske journal, og som er baseret i nærområdet. Handtekening van de persoon die bevoegd is de verklaring namens de fabrikant te tekenen, de technischedocumentatie bewaart en bevoegd is om het technische bestand samen te stellen, en die is gevestigd in het Woongebied. Ühenduse registreeritud isiku allkiri, kes on volitatud tootja nimel deklaratsiooni koostama, kes omab tehnilisdokumentatsiooni ja kellel on õigus koostada tehniline toimik. Sen henkilön allekirjoitus, jolla on valmistajan valtuutus vakuutuksen laadintaan, jolla on hallussaan teknisetasiakirjat, joka on valtuutettu laatimaan tekniset asiakirjat ja joka on sijoitautunut yhteisöön. Signature de la personne habilitée à rédiger la déclaration au nom du fabricant, à détenir la documentation technique, à compiler les fichiers techniques et qui est implantée dans la Communauté. Unterschrift der Person, die berechtigt ist, die Erklärung im Namen des Herstellers abzugeben, die dietechnischen Unterlagen aufbewahrt und berechtigt ist, die technischen Unterlagen zusammenzustellen, und die in der Gemeinschaft niedergelassen ist. Υπογραφή στόμου εξουσιοδοτημένου για την σύνταξη της δήλωσης εκ μέρους του κατασκευαστή, ο οποίος κατέχει την τεχνική έκθεση και έχει την εξουσιοδότηση να ταξινομήσει τον τεχνικό φάκελο και ο οποίος είναι εδρασημένος στην Κοινότητα. A gyártó nevében meghatalmazott személy, akinek jogában áll módosítania a nyilatkozatot, a műszaki dokumentációt őrizi, engedéllyel rendelkezik a műszaki fájł összeállításához, és aki a közösségben telepedett személy. Firma della persona autorizzata a redigere la dichiarazione a nome del fabbricante, in possesso della documentazione tecnica ed autorizzata a costituire il fascicolo tecnico, che deve essere stabilita nella Comunità. Tas personas paraksts, kura ir pilnvarota deklarācijas sastādīšanai ražotāja vārdā, kurai ir tehniskā dokumentācija, kura ir pilnvarota sagatavot tehnisko reģistru un kura ir apstiprināta Kopienā. Asmuo, kuris yra gana žinomas, kuriam gamintojas suteikė įgaliojimus sudaryti šią deklaraciją, ir kuris įpasisirašė, turi visą techninę informaciją ir yra įgaliotas sudaryti techninės informacijos dokumentą. Il-firma tal-persuna awtorizzata li tfassal id-dikjarazzjoni f'isem il-fabbrikant, għandha d-dokumentazzjoni teknika u hija awtorizzata li tikkompila l-fajł tekniku u li hija stabbilita fil-Komunità. Podpis osoby upoważnionej do sporządzenia deklaracji w imieniu producenta, przechowującej dokumentację techniczną, upoważnioną do stworzenia dokumentacji technicznej oraz wyznaczonej ds. wspólnotowych. Assinatura da pessoa com poderes para emitir a declaração em nome do fabricante, que possui a documentação técnica, que está autorizada a compilar o processo técnico e que está estabelecida na Comunidade. Semnătura persoanei împuternicite să elaboreze declarația în numele producătorului, care deține documentația tehnică, este autorizată să compileze dosarul tehnic și este stabilită în Comunitate. Podpis osoby poverenej vystavenim vyhlásenia v mene výrobcu, ktorá má technickú dokumentáciu a je oprávnená spracovať technické podklady a ktorá je umiestnená v Spoločenstve. Podpis osebe, pooblašene za izdelavo izjave v imenu proizvajalca, ki ima tehnično dokumentacijo in lahko sestavlja spis tehnične dokumentacije, ter ima sedež v Skupnosti. Firma de la persona responsable de la declaración en nombre del fabricante, que posee la documentación técnica y está autorizada para recopilar el archivo técnico y que está establecido en la Comunidad. Undertecknas av den som bemyndigad att upprätta deklarationen å tillverkarens vägnar, innehar den tekniskadokumentationen och är bemyndigad att sammanställa den tekniska informationen och som är etablerad igemenskapen.</p>	<p> 2006/42/EC Annex II 1A: 2 Tim Lansdell Technical Director 19th March 2009 Ransomes Jacobsen Limited West Road, Ransomes Europark, Ipswich, England, IP3 9TT</p> <p> 2006/42/EC Annex II 1A: 10 Dawn Bryngelson Technical Documentation Advisor Smithco Inc. 34 West Avenue Wayne, PA USA 19087-3311 10-Dec -09</p>
<p>Certificate Number • Номер на сертификат • Číslo osvědčení • Certifikatnummer • Certificaatnummer • Sertifikaadi number • Hyväksyntänumero • Numéro de certificat • Bescheinigungsnummer • Αριθμός Πιστοποιητικού • Hitelesítési szám • Numero del certificato • Serifikāta numurs • Serifikato numeris • Numru tač-Certifikat • Numer certyfikatu • Número do Certificado • Număr certificat • Číslo osvedčenia • Številka certifikata • Número de certificado • Certifikatsnummer</p>	<p>205002011-1</p>



DECLARATION OF CONFORMITY • ДЕКЛАРАЦИЯ ЗА СЪОТВЕТСТВИЕ • PROHLÁŠENÍ O SHODĚ • OVERENSSTEMMELSESERKLÆRING • CONFORMITEITSVERKLARING • VASTAVUSDEKLARATSIOON • VAATIMUSTENMUKAISUUSVAKUUTUS • DECLARATION DE CONFORMITE • KONFORMITÄTSEKTLÄRUNG • ΔΗΛΩΣΗ ΣΥΜΜΟΡΦΩΣΗΣ • MEGFELELŐSÉGI NYILATKOZAT • DICHIARAZIONE DI CONFORMITÀ • ATBILSTĪBAS DEKLARĀCIJA • ATITIKTIES DEKLARACIJA • DIKJARAZZJONI TAL-KONFORMITÀ • DEKLARACJA ZGODNOŚCI • DECLARAÇÃO DE CONFORMIDADE • DECLARAȚIE DE CONFORMITATE • VYHLÁSENIE O ZHODE • IZJAVA O SKLADNOSTI • DECLARACIÓN DE CONFORMIDAD • DEKLARATION OM ÖVERENSSTÄMMELSE

Business name and full address of the manufacturer • Тяговско име и пълен адрес на производителя • Obchodní jméno a plná adresa výrobce • Producentens firmanavn og fulde adresse • Bedrijfsnaam en volledig adres van de fabrikant • Tootja ärinimi ja täielik address • Valmistajan toiminnimi ja täydellinen osoite • Nom commercial et adresse complète du fabricant • Firmenname und vollständige Adresse des Herstellers • Επισημυγία και ταχυδρομική διεύθυνση κατασκευαστή • A gyártó üzleti neve és teljes címe • Ragione sociale e indirizzo completo del fabbricante • Uzņēmuma nosaukums un pilna ražotāja adrese • Verslo pavadinimas ir pilnas gamintojo adresas • Isem kummetġali u indirizz sħih tal-fabbrikant • Nazwa firmy i pełny adres producenta • Nome da empresa e endereço completo do fabricante • Denumirea comercială și adresa completă a producătorului • Obchodný názov a úplná adresa výrobcu • Naziv podjetja in polni naslov proizvajalca • Nombre de la empresa y dirección completa del fabricante • Tillverkarens företagsnamn och kompletta adress	Smithco Inc. 34 West Avenue Wayne, PA USA 19087-3311
Product Code • Код на продукта • Kód výrobku • Produktkode • Productcode • Toote kood • Tuotekoodi • Code produit • Produktcode • Кодовός προϊόντος • Termékkód • Codice prodotto • Produkta kods • Produkto kodas • Kodici tal-Prodott • Kod produktu • Código do Produto • Cod produs • Kód výrobku • Označka proizvoda • Código de producto • Produktkod	20-700
Machine Name • Наименование на машината • Název stroje • Maskinnavn • Machinenaam • Masina nimi • Laitteen nimi • Nom de la machine • Maschinenbezeichnung • Ονομασία μηχανήματος • Gépnév • Denominazione della macchina • Iekārtas nosaukums • Mašinos pavadinimas • Isem tal-Magna • Nazwa urządzenia • Nome da Máquina • Numele echipamentului • Název stroja • Naziv stroja • Nombre de la máquina • Maskinens namn	Spray Star 2000 Diesel
Designation • Предназначение • Označení • Betegnelse • Benaming • Nimetus • Tuupimerkintä • Pažymėjimas • Bezeichnung • Χαρακτήρισμός • Megnevezés • Funzione • Apzīmējums • Lithuanian • Denominazzjoni • Oznaczenie • Designação • Specificație • Označenie • Namen stroja • Description • Beteckning	Turf Sprayer
Serial Number • Серийн номер • Sériové číslo • Serienummer • Serienummer • Serienummer • Valmistusnumero • Numéro de série • Serienummer • Σειριακός αριθμός • Sorozatszám • Numero di serie • Sérijas numurs • Serijos numeris • Numru Serjali • Numer serjiny • Número de Série • Număr de serie • Sériové číslo • Serijska številka • Número de serie • Serienummer	200D037
Engine • Двигател • Motor • Motor • Motor • Mootor • Mootori • Moteur • Motor • Μηχανή • Modulnėv • Motore • Dzinējs • Variklis • Sahha Netta Installata • Silnik • Motor • Motor • Motor • Motor • Motor • Motor	kubota D1105
Net Installed Power • Нетна инсталпирана мощност • Čistý instalovaný výkon • Installeret nettoeffekt • Netto geïnstalleerd vermogen • Installeeritud netovõimsus • Asennettu nettoteho • Puissance nominale nette • Installierte Nettoleistung • Καθαρή εγκατεστημένη ισχύς • Nettó beépített teljesítmény • Potenza netta installata • Paredzētā tīkla jauda • Grynoji galia • Wisa' tal-Qtaħ • Moc zainstalowana netto • Pot ęncia instalada • Puterea instalată netă • Čistý instalovaný výkon • Neto vgrajena moč • Potencia instalada neta • Nettoeffekt	18.5 kW
Conforms to Directives • В съответствие с директивите • Splūnje podminky směrnic • Er i overensstemmelse med direktiver • Voldoet aan de richtlijnen • Vastab direktividele • Direktiivien mukainen • Conforme aux directives • Entspricht Richtlinien • Ακολουθώτε πιστά τις Οδηγίες • Megfelel az irányelveknek • Conforme alle Direttive • Atbilst direktīvam • Atitinka direktyvų reikalavimus • Valutazzjoni tal-Konformità • Dyrektywy związane • Cumpre as Directivas • Respectă Directivele • Je v súlade so smernicami • Skladnost z direktivami • Cuple con las Directivas • Uppfyller direktiv	2006/42/EC; 2000/14/EC Annex VI . Part 1
Conformity Assessment • Оценка за съответствие • Hodnocení plnění podmínek • Overensstemmelsesvurdering • Conformiteitsbeoordeling • Vastavushindamine • Vaatimustenmukaisuuden arviointi • Evaluation de conformité • Konformitätsbeurteilung • Διαπίστωση Συμμόρφωσης • Megfelelőség-értékelés • Valutazione della conformità • Atbilstības novērtējums • Atitikties įvertinimas • Livell tal-Qawwa tal-Foss Imkejjel • Ocena zgodności • Avaliação de Conformidade • Evaluarea conformității • Vyhodnotenie zhodnosti • Ocena skladnosti • Evaluación de conformidad • Bedømming av overensstammelse	2006/42/EC Annex VIII
Measured Sound Power Level • Измерено ниво на звукова мощност • Naměřený akustický výkon • Målte lydstyrkeniveau • Gemeten geluidsniveau • Mődeltud helvőimsuse tase • Mitattu äänitehotaso • Niveau de puissance sonore mesuré • Gemessener Schalldruckpegel • Σταθμευμένο επίπεδο ηχητικής ισχύος • Mért hangteljesítményszint • Livello di potenza sonora misurato • Izměřitais skaņas jaudas līmenis • Išmatuotas garso stiprumo lygis • Livell tal-Qawwa tal-Foss Iggarrantit • Moc akustyczna mierzona • Nivel sonor medido • Nivelul măsurat al puterii acustice • Namerānā hlada akustiského výkonu • Izmejerena raven zvočne moči • Nivel de potencia sonora medido • Uppmätt ljudeffektsnivå	98dB(A)Lwa
Guaranteed Sound Power Level • Гарантирано ниво на звукова мощност • Garantovaný akustický výkon • Garanteret lydstyrkeniveau • Gegarandeerd geluidsniveau • Garantēitūd helvőimsuse tase • Taattu äänitehotaso • Niveau de puissance sonore garanti • Garanterter Schalldruckpegel • Εγγυημένο επίπεδο ηχητικής ισχύος • Szavatolt hangteljesítményszint • Livello di potenza sonora garantito • Garant ętais skaņas jaudas līmenis • Garantuotas garso stiprumo lygis • Livell tal-Qawwa tal-Foss Iggarrantit • Moc akustyczna gwarantowana • Nivel sonor fantidit • Nivelul garantat al puterii acustice • Garantovanā hlada akustiského výkonu • Zajamčena raven zvočne moči • Nivel de potencia sonora garantizado • Garanterad ljudeffektsnivå	100 dB(A)Lwa
Conformity Assessment Procedure (Noise) • Оценка за съответствие на процедурата (Шум) • Postup hodnocení plnění podmínek (hluk) • Procedure for overensstemmelsesvurdering (Støj) • Procedure van de conformiteitsbeoordeling (geluid) • Vastavushindamismenetlus (mőra) • Vaatimustenmukaisuuden arviointimenetelmä (Melu) • Procédure d'évaluation de conformité (bruit) • Konformitätsbeurteilungsverfahren (Geräusch) • Διαδικασία Αξιολόγησης Συμμόρφωσης (Θόρυβος) • Megfelelőség-értékelési eljárás (Zaj) • Procedura di valutazione della conformità (rumore) • Atbilstības novērtējuma procedūra (troksnis) • Atitikties įvertinimo procedūra (garsas) • Procedura tal-Valutazzjoni tal-Konformità (Foss) • Procedura ocenę zgodności (poziom hałas) • Processo de avaliação de conformidade (nível sonoro) • Procedura de evaluare a conformității (zgomot) • Postup vyhodnocovania zhodnosti (hluk) • Postopek za ugotavljanje skladnosti (hrup) • Procedimiento de evaluación de conformidad (ruido) • Procedur för bedømming av överensstammelse (buller)	2000/14/EC Annex VI Part 1
UK Notified Body for 2000/14/EC • Нотифициран орган в Обединеното кралство за 2000/14/EO • Úřad certifikovaný podle směrnice č. 2000/14/EC • Det britiske bemyndigede organ for 2001/14/EF • Engels adviesorgaan voor 2000/14/EG • Ühendkuningriigi teavitatud asutus direktiivi 2000/14/EÜ mõistes • Direktiivin 2000/14/EY mukainen ilmoitettu tarkastuslaitos Isonsa-Britanniassa • Organisme notifié concernant la directive 2000/14/CE • Britische benannte Stelle für 2000/14/EG • Κοινοποιημένος Οργανισμός Ηνωμένου Βασιλείου για 2000/14/ΕΚ • 2000/14/EK – egyesült királyságbeli bejelentett szervezet • Organismo Notificato in GB per 2000/14/CE • 2000/14/EK AK reģistrētā organizācija • JK notifikuotais jstaisgs 2000/14/EC • Korp Notifikat tar-Renju Unit għal 2000/14/KE • Dopuszczona jednostka badawcza w Wielkiej Brytanii wg 2000/14/WE • Entidade notificada no Reino Unido para 2000/14/CE • Organism notificat în Marea Britanie pentru 2000/14/CE • Notifikovaný orgán Spojeného královstva pre smernicu 2000/14/ES • Britanskí priglašeni organ za 2000/14/ES • Cuerpo notificado en el Reino Unido para 2000/14/CE • Anmält organ för 2000/14/EG i Storbritannien	Smithco West Inc. 200 West Poplar Avenue Cameron, WI 54822 USA
Operator Ear Noise Level • Оператор на нивото на доловим от ухото шум • Hladina hluku v oblasti uší operátora • Støjniveau i førers ørehøjde • Geluidsniveau oor bestuurder • Mőratase operatōri kőrvas • Melutaso käyttöjān korvan kohdalla • Niveau de bruit à hauteur des oreilles de l'opérateur • Schallpegel am Bedienerohr • Επίπεδο θορύβου σε λειτουργία • A kezelő fülénél mért zajszint • Livello di potenza sonora all'orecchio dell'operatore • Troškņa līmenis pie operatora auss • Dirbančiojo su mašina patiriamio triukšmo lygis • Livell tal-Foss fil-Widna tal-Operatur • Dopuszczalny poziom hałasu dla operatora • Nivel sonor nos ouvidos do operador • Nivelul zgomotului la urechea operatorului • Hladina hluku pôsobaca na sluch operátora • Raven hrupa pri užesu upravljanca • Nivel sonor en el oïdo del operador • Ljudnivå vid förärens öra	98 dB(A)Lwa (2006/42/EC)

<p>Harmonised standards used • Използвани хармонизирани стандарти • Použité harmonizované normy • Brugte harmoniserede standarder • Gebruikte geharmoniseerde standaards • Kasutatud ühtlustatud standardid • Käytetyt yhdenmukaistetut standardit • Normes harmonisées utilisées • Angewandte harmonisierte Normen • Ευρωπαϊκά αρμονισμένα πρότυπα που χρησιμοποιήθηκαν • Harmonizált szabványok • Standard armonizzati applicati • Izmantotie saskapotie standarti • Panaudoti suderinti standartai • Standards armonizzati usati • Normy spójne powiązane • Normas harmonizadas usadas • Standardele armonizate utilizate • Použité harmonizované normy • Uporabljeni usklajeni standardi • Estándares armonizados utilizados • Harmoniserade standarder som används</p>	<p>BS EN ISO 12100-1:2003 BS EN ISO 12100-2:2003 BS EN ISO 13857 BS EN 349: 1993-A1:2008 BS 6356: P8 BS 6356: P5 BS EN 907</p>
<p>Technical standards and specifications used • Използвани технически стандарти и спецификации • Použité technické normy a specifikace • Brugte tekniske standarder og specifikationer • Gebruikte technische standaards en specificaties • Kasutatud tehnilised standardid ja spetsifikatsioonid • Käytetyt tekniset standardit ja eritelmät • Spécifications et normes techniques utilisées • Angewandte technische Normen und Spezifikationen • Τεχνικά πρότυπα και προδιαγραφές που χρησιμοποιήθηκαν • Műszaki szabványok és specifikációk • Standard tecnici e specifiche applicati • Izmantotie tehniške standarti un specifikācijas • Panaudoti techniniai standartai ir techninė informacija • Standards u specifikacijonijiet techni užati • Normy i specyfikacje techniczne powiązane • Normas técnicas e especificações usadas • Standardele tehnice și specificațiile utilizate • Použité technické normy a špecifikácie • Uporabljeni tehnični standardi in specifikacije • Estándares y especificaciones técnicas utilizadas • Tekniska standarder och specifikationer som används</p>	<p>ISO 21299 2002/44/EC SAE J1362</p>
<p>The place and date of the declaration • Място и дата на декларацията • Misto a datum prohlášení • Sted og dato for erklæringen • Plaats en datum van de verklaring • Deklaratsiooni väljastamise koht ja kuupäev • Vakuutuksen paikka ja päivämäärä • Lieu et date de la déclaration • Ort und Datum der Erklärung • Τόπος και ημερομηνία δήλωσης • A nyilatkozat kelte (hely és idő) • Luogo e data della dichiarazione • Deklarācijas vieta un datums • Deklarācijas vieta ir data • Il-post u d-data tad-dikjarazzjoni • Miejsce i data wystawienia deklaracji • Local e data da declaração • Local și data declarației • Miesto a data deklarației • Kraj in datum izjave • Lugar y fecha de la declaración • Plats och datum för deklarationen</p>	<p>Smithco West Inc. 200 West Poplar Avenue Cameron, WI 54822 USA 24-Jun -09</p>
<p>Signature of the person empowered to draw up the declaration on behalf of the manufacturer, holds the technical documentation and is authorised to compile the technical file, and who is established in the Community. Подпис на човека, упълномощен да състави декларацията от името на производителя, който поддържа техническата документация и е оторизиран да изготви техническия файл и е регистриран в общността. Podpis osoby oprávněné sestavit prohlášení jménem výrobce, držet technickou dokumentaci a osoby oprávněné sestavit technické soubory a založené v rámci Evropského společenství. Underskrift af personen, der har fuldmagt til at udarbejde erklæringen på vegne af producenten, der er indehaver af dokumentationen og er bemyndiget til at udarbejde den tekniske journal, og som er baseret i nærområdet. Handtekening van de persoon die bevoegd is de verklaring namens de fabrikant te tekenen, de technische documentatie bewaart en bevoegd is om het technische bestand samen te stellen, en die is gevestigd in het Woongebied. Ühenduse registrisse kantud isiku allkir, kes on volitatud tootja nimel deklaratsiooni koostama, kes omab tehnilisdokumentatsiooni ja kellel on õigus koostada tehniline toimik. Sen henkilöön allekirjoitus, jolla on valmistajan valtuutus vakuutuksen laadintaan, jolla on hallussaan teknisetasiakirjat, joka on valtuutettu laatimaan tekniset asiakirjat ja joka on sijoittautunut yhteisöön. Signature de la personne habilitée à rédiger la déclaration au nom du fabricant, à détenir la documentation technique, à compiler les fichiers techniques et qui est implantée dans la Communauté. Underschrift der Person, die berechtigt ist, die Erklärung im Namen des Herstellers abzugeben, die dietechnischen Unterlagen aufbewahrt und berechtigt ist, die technischen Unterlagen zusammenzustellen, und die in der Gemeinschaft niedergelassen ist. Υπογραφή ατόμου εξουσιοδοτημένου για την σύνταξη της δήλωσης εκ μέρους του κατασκευαστή, ο οποίος κατέχει την τεχνική έκθεση και έχει την εξουσιοδότηση να ταξινομήσει τον τεχνικό φάκελο και ο οποίος είναι διορισμένος στην Κοινότητα. A gyártó nevében meghatalmazott személy, akinek jogában áll módosítania a nyilatkozatot, a műszaki dokumentációt írni, engedéllyel rendelkezik a műszaki fájllal összeállításához, és aki a közösségben telepedett személy. Firma della persona autorizzata a redigere la dichiarazione a nome del fabbricante, in possesso della documentazione tecnica ed autorizzata a costituire il fascicolo tecnico, che deve essere stabilita nella Comunità. Tās personas paraksts, kura ir pilnvarota deklarācijas sastādīšanai ražotāja vārdā, kurai ir tehniskā dokumentācija, kura ir pilnvarota sagatavot tehnisko reģistru un kura ir apstiprināta Kopienā. Asmuo, kuris yra gana žinomas, kuriam gamintojas suteikė įgaliojimus sudaryti šią deklaraciją, ir kuris įspasirašė, turi visą techninę informaciją ir yra įgaliotas sudaryti techninės informacijos dokumentą. Il-firma tal-persuna awtorizzata li fassal id-dikjarazzjoni f'isem il-fabbrikant, għandha d-dokumentazzjonetknika u hija awtorizzata li tikkompila l-fajl tekniku u li hija stabbilita fil-Komunità. Podpis osoby upoważnionej do sporządzenia deklaracji w imieniu producenta, przechowującej dokumentację techniczną, upoważnioną do stworzenia dokumentacji technicznej oraz wyznaczonej ds. wspólnotowych. Assinatura da pessoa com poderes para emitir a declaração em nome do fabricante, que possui a documentação técnica, que está autorizada a compilar o processo técnico e que está estabelecida na Comunidade. Semnătura persoanei împuternicite să elaboreze declarația în numele producătorului, care deține documentația tehnică, este autorizată să compileze dosarul tehnic și este stabilită în Comunitate. Podpis osoby poverenej vystavenim vyhlášení v mene výrobce, ktorá má technickú dokumentáciu a je oprávnená spracovať technické podklady a ktorá je umiestnená v Spoločenstve. Podpis osebe, pooblašćene za izdelavo izjave v imenu proizvajalca, ki ima tehnično dokumentacijo in lahko sestavlja spis tehnične dokumentacije, ter ima sedež v Skupnosti. Firma de la persona responsabile de la declaración en nombre del fabricante, que posee la documentación técnica y está autorizada para recopilar el archivo técnico y que está establecido en la Comunidad. Under tecknas av den som bemyndigad att upprätta deklarationen å tillverkarens vägnar, innehar den tekniskadokumentationen och är bemyndigad att sammanställa den tekniska informationen och som är etablerad igemenskapen.</p>	<p> 2006/42/EC Annex II 1A: 2 Tim Lansdell Technical Director 19th March 2009 Ransomes Jacobsen Limited West Road, Ransomes Europark, Ipswich, England, IP3 9TT</p> <p> 2006/42/EC Annex II 1A: 10 Dawn Bryngelson Technical Documentation Advisor Smithco Inc. 34 West Avenue Wayne, PA USA 19087-3311 10-Dec -09</p>
<p>Certificate Number • Номер на сертификат • Číslo osvědčení • Certifikatnummer • Certificaatnummer • Sertifikaadi number • Huväksyntänumero • Numéro de certificat • Bescheinigungsnummer • Αριθμός Πιστοποιητικού • Hitelesítési szám • Numero del certificato • Serifikáta numers • Serifikato numeris • Numru tač-Certifikat • Numer certyfikatu • Número do Certificado • Număr certificat • Číslo osvedčenia • Številka certifikata • Número de certificado • Certifikatsnummer</p>	<p>207002013-1</p>



QUICK REFERENCE

REPLACEMENT FILTERS

50-403	Inline Fuel Filter	
20-576	Hydraulic Oil Filter Assembly	
20-576-01	Oil Filter Replacement Element	
76-487	Engine Oil Filter	Briggs # 942921
76-395-01	Remote Air Cleaner Cartridge	
76-395-02	Remote Safety Filter Cartridge	

REPLACEMENT BELTS

30-137	Spray Pump V-Belt
--------	-------------------

SEAL KITS

15-301	Power Steering Orbital Motor
15-301-01	Seal Kit
15-839	Hydraulic Cylinder
14-531	Seal Kit
43-116	Wheel Motors
14-080	Seal Kit
76-482	Hydrostatic Pump
77-239-22	Seal Kit
76-197	Gear Pump
76-197-08	Seal Kit

FLUIDS

Engine Oil	SAE 10W-40 API Service SJ or higher Motor Oil
Hydraulic Fluid	SAE 10W-40 API Service SJ or higher Motor Oil

OTHER PARTS

16-953	Hinged Cover On Tank with Gasket
16-953-01	Gasket For Cover
20-663	Tank Lid Gasket
15-818	#75 Fitting O-ring
15-817	#50 Fitting O-ring
13-488	Key Switch
76-310	Key Set

Cyclonic air cleaner
76-395-04

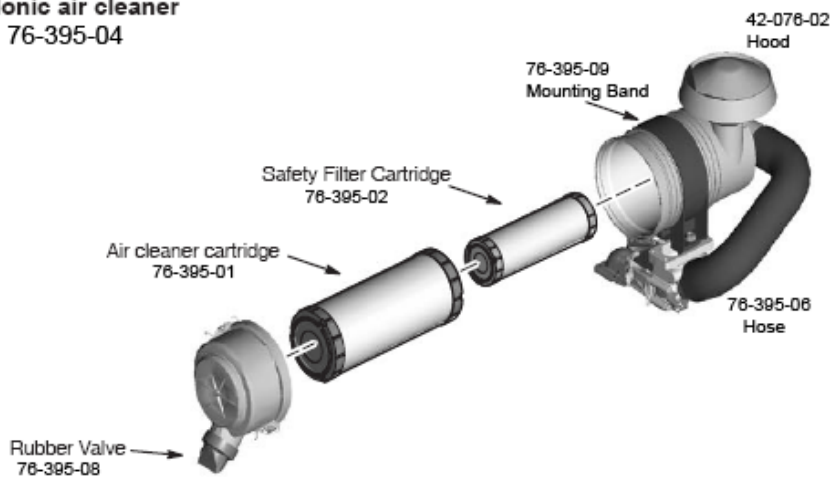

The Smithco Commercial Products Two-Year Limited Warranty

The Smithco Commercial Products Two-Year Limited Warranty

Smithco, Inc. (Smithco) warrants your 2016 or newer Smithco Commercial Product ("Product") purchased after October 1, 2016 to be free from defects in materials or workmanship for the period of time listed below. Where a warrantable condition exists, Smithco will repair the Product at no cost to you including diagnosis, labor (at the Smithco standard labor rate, subject to the Smithco flat rate schedule), and parts.

Warranty Duration is:

- (1) Two years, 1500 operational hours* from the date of delivery to the original purchaser or Five years from the date of original manufacturer of the product, whichever occurs first. (*Products equipped with hour meter).
- (2) Products used in rental situations are covered for 90 days from date of delivery to original user/renter.

Owner Responsibilities:

As the Product owner, you are responsible for required maintenance and adjustments stated in your Owner's Manual. Failure to perform required maintenance and adjustments can be grounds for disallowing a warranty claim. **You are particularly responsible to train all present and future operators of this product on the safe operation of this product at your location.**

Instructions for Obtaining Warranty Service:

You are responsible for notifying the Authorized Smithco Products Distributor from whom you purchased the Product as soon as you believe a warrantable condition exists and not later than 30 days from discovery of the condition.





If you need help locating an Authorized Smithco Distributor, or if you have questions regarding your warranty rights or responsibilities, you may contact us at:

Smithco Product Support Department
200 West Poplar Ave.
Cameron, Wisconsin 54822
Telephone: 800-891-9435 E-Mail: ProductSupport@Smithco.com

Maintenance Parts:

Parts scheduled for replacement as required maintenance ("Maintenance Parts"), are warranted for the period of time up to the scheduled replacement time for that part.

Items/Conditions Not Covered:

-  Not all product failures or malfunctions that occur during the warranty period are defects in materials or workmanship. The items/conditions listed below are not covered by this warranty:
-  Product failures which result from the use of non-Smithco replacement parts, or from installation and use of add-on, modified, or unapproved accessories are not covered.
-  Product failures which result from failure to perform required maintenance and/or adjustments are not covered.
-  Product failures that result from operating the Product in an abusive, negligent or reckless manner are not covered.



This warranty does not apply to parts subject to consumption through use, unless found to be defective. Examples of parts which are consumed, or used up, during normal Product operation include, but are not limited to: blades, tines, teeth, scarifiers, rakes, plates, wear plates, castor wheels, tires, batteries, filters, belts, nozzles, etc.



This warranty does not apply to failures caused by outside influence. Items considered to be outside influence include, but are not limited to, weather, storage practices, contamination, use of unapproved coolants, lubricants, additives, or chemicals, etc.



This warranty does not apply to normal "wear and tear" items. Normal "Wear and Tear" includes, but is not limited to, damage to seats due to wear or abrasion, worn painted surfaces, scratched decals or windows, etc.



Smithco may require the return of failed parts or components in order to determine the validity of any warranty claim.



Smithco will not be obligated to replace components of other manufacturers if inspection by the original component manufacturer indicates that failure was due to normal wear and tear, expected consumption through use or improper care or service.

Other Legal Disclaimers:

The above remedy for product defects through repair or replacement by an authorized Smithco distributor or dealer is the purchaser's sole remedy for any defect. This warranty gives you specific legal rights, and you may also have other rights which vary from state to state.

THERE ARE NO OTHER EXPRESS WARRANTIES OTHER THAN THOSE SET FORTH ABOVE. ALL IMPLIED WARRANTIES OF MERCHANTABILITY AND FITNESS FOR USE ARE LIMITED TO THE DURATION OF THE LIMITED WARRANTIES CONTAINED HEREIN.

Some states may not allow limitations on how long an implied warranty lasts, so the above limitation may not apply to you.

THE SMITHCO COMPANY IS NOT LIABLE FOR INDIRECT, INCIDENTAL OR CONSEQUENTIAL DAMAGES IN CONNECTION WITH THE USE OF THE PRODUCT, INCLUDING ANY COST OR EXPENSE OF PROVIDING A SUBSTITUTE PRODUCT OR SERVICE DURING PERIODS OF MALFUNCTION OR NON-USE.

Some states may not allow the exclusion of indirect, incidental or consequential damages, so the above exclusion may not apply to you.

